

**Phystech.International Olympiad in Biology**  
**2020/21 academic year**  
**Online qualifying stage**



**TASKS FOR PRE-GRADUATING LEVEL**

**The Olympiad tasks are divided into three parts:**

**Part A:** Tasks with one correct answer (14 tasks, 15 points in total)

**Part B:** Multiple Choice Questions (10 tasks, 30 points in total)

**Part C:** Matching Questions (5 tasks, 25 points in total)

**Total: 70 points**

## **Part A: Tasks with one correct answer**

In all the tasks of this part, there is a condition at the beginning, and then four answer options (under the letters from A to D). Participants need to determine which one of the answer options is correct (fits the wording of the task). Each task can have only one correct answer. For each question, the number of points for the correct answer is indicated: there are two costs - 1 point each and 2 points each.

### **Grading system:**

For each correct answer - 1 or 2 points

For each wrong answer - 0 points

### Task 1 (ID 1) - 1 point

Common part of the question for all variants:

**Russian biologist S. Navashin made a decisive contribution to the discovery of the process of double fertilization in angiosperms in 1898. In the course of this process, not only the fertilization of the egg takes place, but also the formation of a cell that gives rise to a special tissue – endosperm.**



**In general, the seed cells, which are part of the endosperm and store nutrients for the embryo, have a set of chromosomes:**

*Variant 1:*

- A) diploid in gymnosperms, diploid in angiosperms;
- B) haploid in gymnosperms, triploid in angiosperms;
- C) diploid in gymnosperms, triploid in angiosperms;
- D) diploid in ferns, diploid in gymnosperms;

*Variant 2:*

- A) haploid in gymnosperms, diploid in angiosperms;
- B) diploid in gymnosperms, diploid in angiosperms;
- C) haploid in gymnosperms, triploid in angiosperms;
- D) haploid in ferns, triploid in angiosperms;

*Variant 3:*

- A) haploid in gymnosperms, triploid in angiosperms;
- B) diploid in gymnosperms, triploid in angiosperms;
- C) haploid in ferns, triploid in gymnosperms;
- D) triploid in ferns, haploid in gymnosperms;

**Task 2 (ID 2) - 1 point**

*Common part of the question for all variants:*

**Secondary growth of the stem caused by the activity of the lateral meristem – cambium is typical for:**

*Variant 1:*

- A) mosses, gymnosperms, angiosperms;
- B) monocotyledonous angiosperms, gymnosperms;
- C) ferns, dicotyledonous angiosperms;
- D) gymnosperms and dicotyledons angiosperms;

*Variant 2:*

- A) mosses and angiosperms;
- B) gymnosperms and dicotyledons angiosperms;
- C) monocotyledonous and dicotyledonous angiosperms;
- D) ferns, gymnosperms;

*Variant 3:*

- A) gymnosperms and dicotyledons angiosperms;
- B) mosses and gymnosperms;
- C) monocotyledonous angiosperms, gymnosperms;
- D) ferns, monocotyledonous angiosperms;

### Task 3 (ID 5) - 1 point

Common part of the question for all variants:

**Multicellular bilaterally symmetric animals from the clade *Nephrozoa* can be divided into *Protostomia* and *Deuterostomia*. Choose the answer option that most fully lists the phylum that belong to *Deuterostomia*:**

Variant 1:

- A) *Chordata*, *Echinodermata*, *Hemichordata*;
- B) only *Chordata*;
- C) *Arthropoda*, *Mollusca*, *Annelida*;
- D) *Plathelminthes* and *Nematoda*;

Variant 2:

- A) only *Echinodermata*;
- B) *Chordata*, *Echinodermata*, *Hemichordata*;
- C) *Arthropoda*;
- D) *Arthropoda*, *Nematoda*, *Annelida*;

Variant 3:

- A) only *Chordata* and *Echinodermata*;
- B) *Plathelminthes* and *Nematoda*;
- C) *Arthropoda*, *Nematoda*, *Annelida*;
- D) *Chordata*, *Echinodermata*, *Hemichordata*;

**Task 4 (ID 6) - 1 point**

Common part of the question for all variants:

The figure below shows schematic diagrams of the circulatory system in various groups of vertebrates.

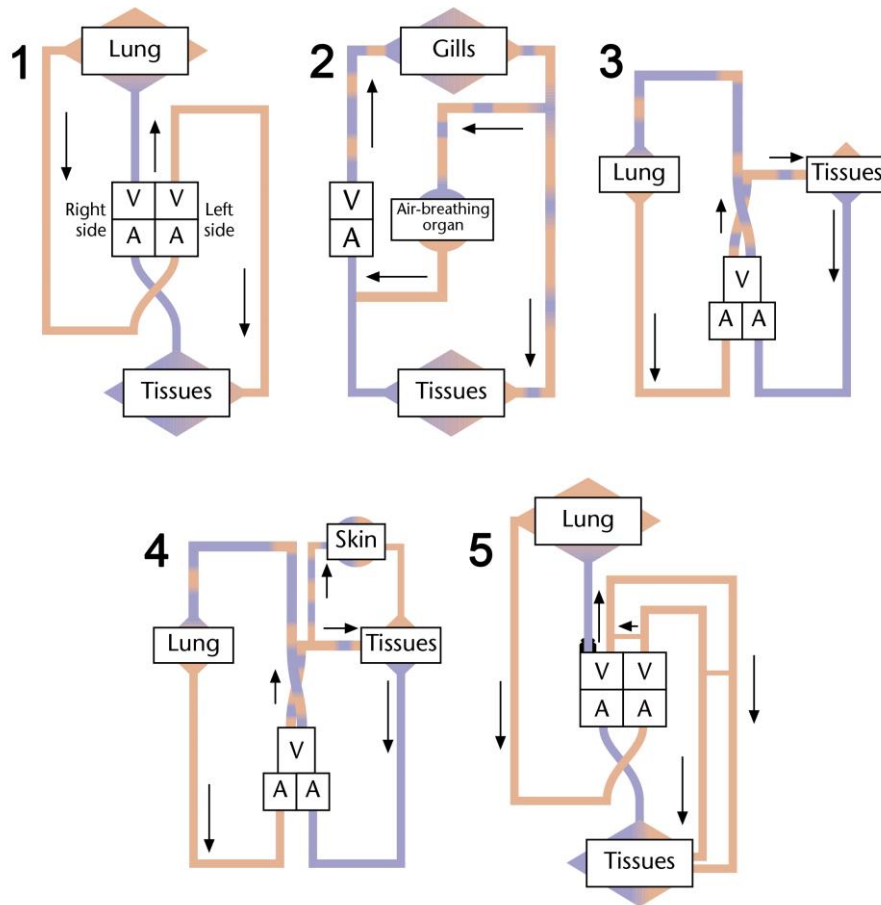

**Description:** A = atrium, V = ventricle. Inspect diagrams, and determine which groups of vertebrates belongs each circulatory system:

*Variant 1:*

- A) 1 – crocodiles, 2 – sharks, 3 – snakes, lizards, turtles, 4 – urodele amphibian, 5 – birds and mammals;
- B) 1 – birds and mammals, 2 – anuran amphibian, 3 – snakes, lizards, turtles, 4 – fish that can breathe through the skin, 5 – crocodiles;
- C) 1 – crocodiles, 2 – air-breathing fish, 3 – urodele amphibian, 4 – snakes, lizards, turtles, 5 – birds and mammals;
- D) 1 – birds and mammals, 2 – air-breathing fish, 3 – snakes, lizards, turtles, 4 – urodele amphibian, 5 – crocodiles;

*Variant 2:*

- A) 1 – birds and mammals, 2 – sharks, 3 – urodele amphibian, 4 – crocodiles, 5 – snakes, lizards, turtles;
- B) 1 – birds and mammals, 2 – snakes, lizards, turtles, 3 – crocodiles, 4 – urodele amphibian, 5 – air-breathing fish;
- C) 1 – birds and mammals, 2 – air-breathing fish, 3 – snakes, lizards, turtles, 4 – urodele amphibian, 5 – crocodiles;
- D) 1 – crocodiles, 2 – air-breathing fish, 3 – urodele amphibian, 4 – snakes, lizards, turtles, 5 – birds and mammals;

*Variant 3:*

- A) 1 – birds and mammals, 2 – air-breathing fish, 3 – snakes, lizards, turtles, 4 – urodele amphibian, 5 – crocodiles;
- B) 1 – crocodiles, 2 – air-breathing fish, 3 – snakes, lizards, turtles, 4 – urodele amphibian, 5 – birds and mammals;
- C) 1 – birds and mammals, 2 – anuran amphibian, 3 – snakes, lizards, turtles, 4 – fish that can breathe through the skin, 5 – crocodiles;
- D) 1 – birds and mammals, 2 – snakes, lizards, turtles, 3 – crocodiles, 4 – urodele amphibian, 5 – air-breathing fish;

### Task 5 (ID 9) - 1 point

Common part of the question for all variants:

Vertebrate whole blood consists of plasma and suspended cells or fragments. The following statements relate to the composition of a normal blood sample.

- 1) Red cells get their color from the waste CO<sub>2</sub> carried by hemoglobin;
  - 2) Erythrocytes are the most abundant cell type in blood;
  - 3) Platelets contain a nucleus and DNA;
  - 4) Hemoglobin is composed of two polypeptide chains;
  - 5) Gamma-globulin is a key protein in plasma;
  - 6) All adult blood cells originate in the bone marrow;
- Which one of the following combinations contains only true statements?

Variant 1:

- A) 4, 5, 6;
- B) 2, 5, 6;
- C) 2, 3, 5, 6;
- D) 1, 2, 3;

Variant 2:

- A) 2, 5, 6;
- B) 3, 4, 5;
- C) 1, 2, 3, 4, 6;
- D) 2, 3, 5, 6;

Variant 3:

- A) 2, 4, 6;
- B) 1, 2, 3, 4, 6;
- C) 2, 5, 6;
- D) 2, 4, 5, 6;



### Task 6 (ID 10) – 1 point

Common part of the question for all variants:

The volume of blood pumped by each ventricle during a beat is known as systolic volume. If the systolic volume is multiplied by the number of beats per minute, the resulting value is the cardiac cost.

Cardiac cost = systolic volume \* cardiac frequency

Variant 1:

Which is the cardiac cost (volume of blood pumped by each ventricle in a minute) of an adult person in rest whose heart beats 72 times per minute and pumps 70 milliliters of blood in each contraction?

- A) 3 l/min;
- B) 5 l/min;
- C) 10 l/min;
- D) 50 l/min;

Variant 2:

Which is the cardiac cost (volume of blood pumped by each ventricle in a minute) of an adult person in rest whose heart beats 55 times per minute and pumps 90 milliliters of blood in each contraction?

- A) 3 l/min;
- B) 5 l/min;
- C) 10 l/min;
- D) 50 l/min;

Variant 3:

Which is the cardiac cost (volume of blood pumped by each ventricle in a minute) of an adult person in rest whose heart beats 67 times per minute and pumps 90 milliliters of blood in each contraction?

- A) 0,6 l/min;
- B) 3 l/min;
- C) 6 l/min;
- D) 60 l/min;

**Task 7 (ID 13) – 1 point**

Common part of the question for all variants:

The figure below shows the formulas for nine different proteinogenic amino acids.

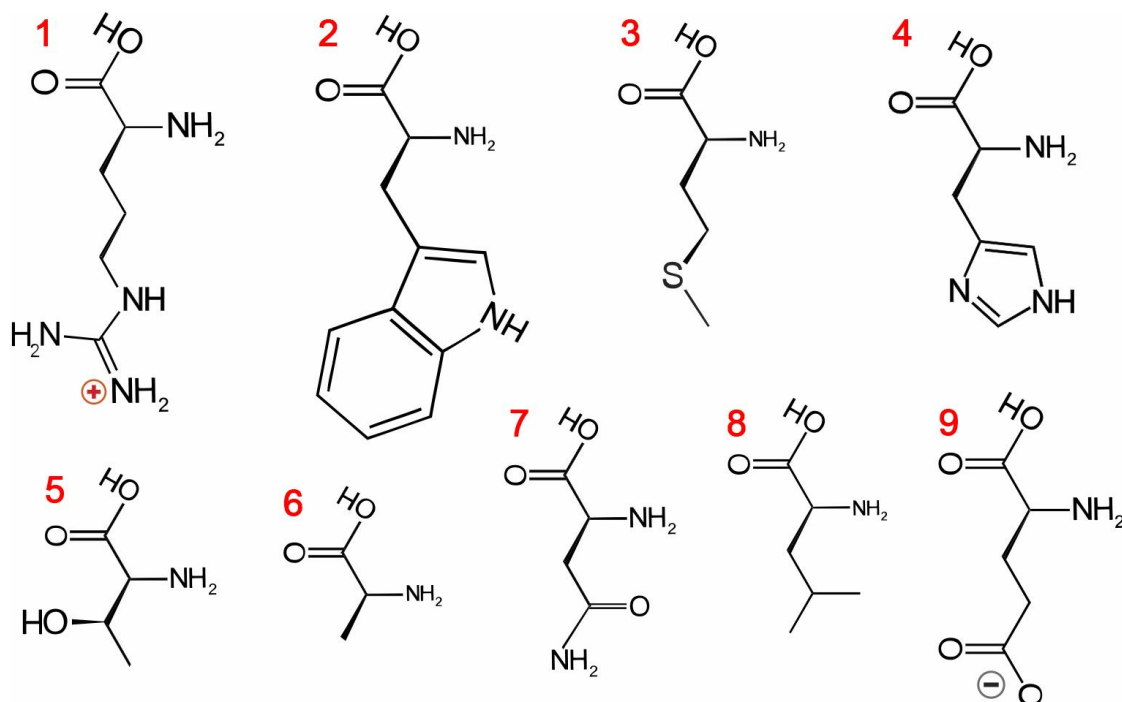

Variant 1:

Which of the following amino acids have a non-polar aliphatic side chain?

- A) 2, 6;
- B) 3, 6, 8;
- C) 2, 3, 5, 8;
- D) 6, 8;

Variant 2:

Which of the following amino acids have a polar uncharged side chain?

- A) 5, 7;
- B) 2, 4, 8;
- C) 3, 4, 5, 7;
- D) 2, 3, 4, 5, 6, 7, 8;

Variant 3:

Which of the following amino acids have an electrically charged side chain?

- A) 1, 9;
- B) 1, 4, 9;
- C) 1, 4, 7;
- D) 5, 7, 9;

**Task 8(ID 14) - 1 point**

Common part of the question for all variants:

Mitochondria are the primary site in cells for the metabolism of long-chain fatty acids, and use a process called beta-oxidation. One cycle of beta-oxidation of a fatty acid, which has been prior activated to a coenzyme A (CoA) ester, is shown below:

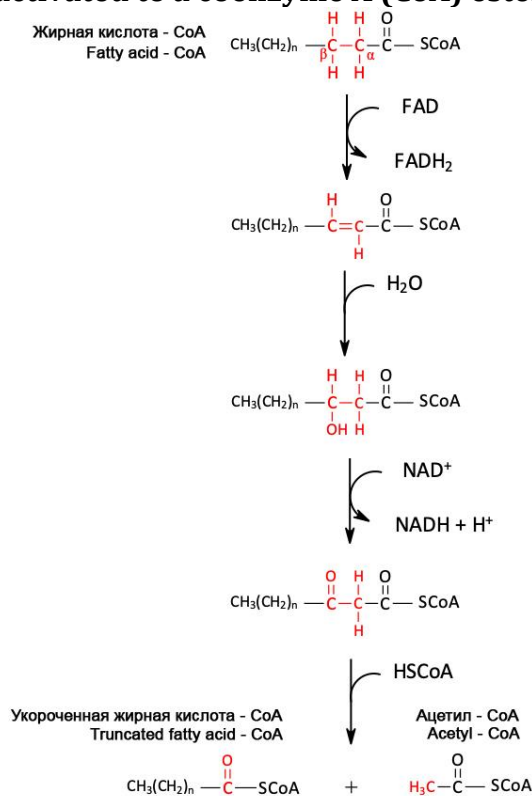

Variant 1:

Based on this diagram, how many cycles of the pathway would be needed for complete beta-oxidation of stearic acid (C<sub>18:0</sub>)?

- A) 7;
- B) 8;
- C) 9;
- D) 10;

Variant 2:

Based on this diagram, how many cycles of the pathway would be needed for complete beta-oxidation of palmitic acid (C<sub>16:0</sub>)?

- A) 7;
- B) 8;
- C) 9;
- D) 10;

Variant 3:

Based on this diagram, how many cycles of the pathway would be needed for complete beta-oxidation of arachidic acid (C<sub>20:0</sub>)?

- A) 7;
- B) 8;
- C) 9;
- D) 10;

**Task 9 (ID 17) – 1 point**

*Common part of the question for all variants:*

**Which of the following structures and processes can simultaneously exist in all prokaryotic and eukaryotic cells?**

- 1) Nuclear envelope;**
- 2) Ribosomes;**
- 3) Introns in genes;**
- 4) ATP synthesis processes;**
- 5) Cytoplasmic membrane;**
- 6) DNA polymerase;**
- 7) Actin cytoskeleton;**
- 8) 18S rRNA.**

*Variant 1:*

- A) 2, 3, 5, 7, 8;
- B) 2, 4, 5, 6;
- C) 2, 4, 6, 7, 8;
- D) 1, 3, 7, 8;

*Variant 2:*

- A) 1, 2, 3, 8;
- B) 2, 4, 5, 7;
- C) 2, 4, 5, 6;
- D) 4, 5, 6, 7;

*Variant 3:*

- A) 2, 4, 6;
- B) 2, 4, 5, 6;
- C) 1, 3, 7, 8;
- D) 4, 5, 6, 7;

**Task 10 (ID 18) - 1 point**

Common part of the question for all variants:

The bacterial cell has spherical shape with a diameter of 1 micron and contains one molecule of genomic DNA. Calculate the molar concentration of DNA in this cell.

For the calculation, use the following data: Avogadro's number =  $6.02 \cdot 10^{23}$ , 1 micron =  $1 \cdot 10^{-6}$  m, the volume formula is  $V = 4/3 \cdot \text{Pi} \cdot R^3$ , where R is the radius of the sphere, and Pi = 3.1415.

Variant 1:

- A)  $3.9 \cdot 10^{-10}$  M;
- B)  $3.3 \cdot 10^{-9}$  M;
- C)  $3.3 \cdot 10^{-7}$  M;
- D)  $7.5 \cdot 10^{-10}$  M;

Variant 2:

- A)  $3.9 \cdot 10^{-10}$  M;
- B)  $3.3 \cdot 10^{-8}$  M;
- C)  $3.3 \cdot 10^{-9}$  M;
- D)  $8 \cdot 10^{-9}$  M;

Variant 3:

- A)  $3.3 \cdot 10^{-9}$  M;
- B)  $3.9 \cdot 10^{-10}$  M;
- C)  $3.9 \cdot 10^{-11}$  M;
- D)  $5 \cdot 10^{-10}$  M;

### Task 11 (ID 21) - 1 point

Common part of the question for all variants:

One of the main systems of blood groups in humans is the ABO system, in which there are four blood groups I (0), II (A), III (B) and IV (AB). The gene responsible for determining this blood group can exist in three variants (alleles) - A, B and 0. Moreover, gene variants A and B always dominate over variant 0, but do not show dominance relative to each other. If a woman who is heterozygous for blood group A married a man with blood group IV, then what is the probability that their children will have blood groups II and III?

Variant 1:

- A) II - 25%, III - 50%;
- B) II - 75%, III - 25%;
- C) II - 50%, III - 50%;
- D) II - 50%, III - 25%;

Variant 2:

- A) II - 25%, III - 25%;
- B) II - 50%, III - 50%;
- C) II - 50%, III - 25%;
- D) II - 0%, III - 25%;

Variant 3:

- A) II - 25%, III - 50%;
- B) II - 25%, III - 75%;
- C) II - 25%, III - 0%;
- D) II - 50%, III - 25%;

**Task 12 (ID 22) - 1 point**

Common part of the question for all variants:

Thomas Hunt Morgan crossed *Drosophila* of two known genotypes, BbVv x bbvv, where the B-wild type (gray) body, is dominant over b (blackbody) allele. Allele V (wild-type wings) is dominant over v (vestigial, a very small wings). Morgan expected to see flies of four phenotypes in a ratio 1: 1: 1: 1. But he observed a completely different picture: Wild type: 965, Black body vestigial: 944, Gray body vestigial: 206, Black body normal wings: 185. These results can be explained, if we assume that alleles are linked and the presence of genetic recombination processes (crossing over).

In this example, the recombination frequency (defined as the ratio of recombinants in relation to total offspring) is:

Variant 1:

- A) 0.080;
- B) 0.170;
- C) 0.205;
- D) 0.500

Variant 2:

- A) 0.900;
- B) 0.270
- C) 0.170;
- D) 0.125;

Variant 3:

- A) 0.108;
- B) 0.125;
- C) 0.170;
- D) 0.500

### Task 13 (ID 25) - 1 point

Common part of the question for all variants:

Ernst Mayr defined biological species as “groups of actually or potentially interbreeding natural populations that are isolated from other such groups by one or more mechanisms of reproductive isolation”. For which of the following organism couplets is the observation provided sufficient to call them distinct biological species?

- 1) Two populations are fixed for competing alleles in the wild. But heterozygous individuals can be produced in laboratory setting;
- 2) No mating can be found between Dalmatian and Chihuahua dogs as their body sizes differ dramatically;
- 3) Females of two firefly species each only respond to the light signal issued by their conspecific males;
- 4) A male and a female moth sample caged in a box failed to mate and lay eggs;
- 5) Two individuals of stag beetles with prominent difference in mandible morphology employ the same of sex pheromones.

Variant 1:

- A) 1 and 2;
- B) 1 and 3;
- C) only 1;
- D) only 3;

Variant 2:

- A) 2 and 3;
- B) 4 and 5;
- C) only 3;
- D) only 5;

Variant 3:

- A) only 3;
- B) 1 and 2;
- C) 3 and 4;
- D) 4 and 5;



**Task 14 (ID 26) - 2 points**

Common part of the question for all variants:

The characteristics of eight taxonomic groups indicated with A up to H are shown in the following table.

Group	Amniotic egg	Chorda	Hair	Legs	Bony skeleton	Teeth/Jaws
A	-	+	-	-	-	-
B	+	+	+	+	+	+
C	-	+	-	-	+	+
D	-	+	-	+	+	+
E	+	+	-	+	+	+
F	+	+	+	+	+	+
G	-	+	-	-	-	+
H	-	-	-	-	-	-

References: "+" - feature present, "-" - feature absent

Based upon these features complete the following evolutionary tree by writing the correct taxon group letters in the corresponding branches. Choose the correct combination of cell numbers and taxon group letters.

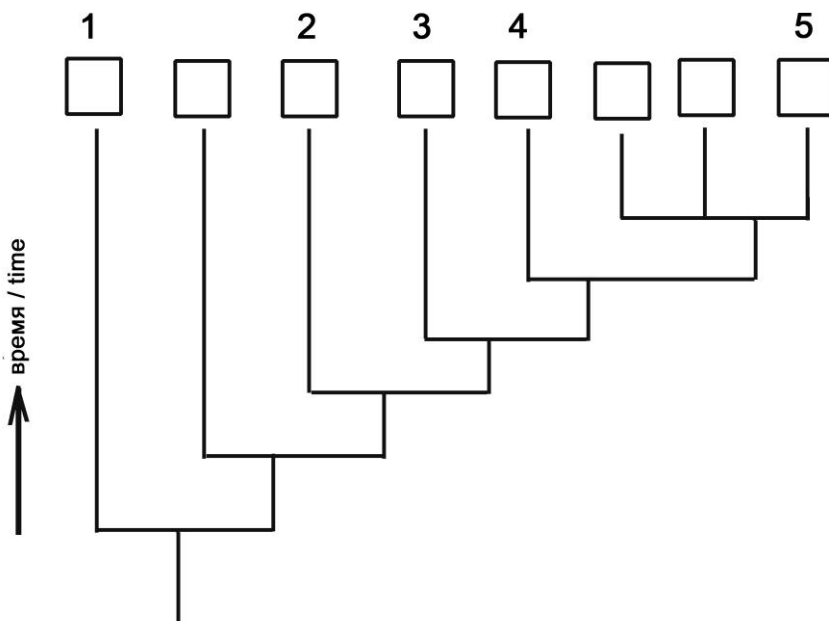

Variant 1:

- A) 1 - B, 2 - D, 3 - C, 4 - G, 5 - H;
- B) 1 - H, 2 - G, 3 - C, 4 - D, 5 - E;
- C) 1 - H, 2 - G, 3 - D, 4 - C, 5 - E;
- D) 1 - H, 2 - G, 3 - C, 4 - D, 5 - F;

Variant 2:

- A) 1 - F, 2 - D, 3 - C, 4 - G, 5 - H;
- B) 1 - H, 2 - A, 3 - D, 4 - C, 5 - E;
- C) 1 - H, 2 - G, 3 - C, 4 - D, 5 - B;
- D) 1 - H, 2 - G, 3 - C, 4 - D, 5 - E;

*Variant 3:*

- A) 1 – H, 2 – G, 3 – C, 4 – D, 5 – E;
- B) 1 – F, 2 – D, 3 – C, 4 – G, 5 – H;
- C) 1 – H, 2 – A, 3 – C, 4 – D, 5 – E;
- D) 1 – H, 2 – G, 3 – C, 4 – D, 5 – F;

## **Part B: Multiple Choice Questions (True / False)**

In all the tasks of this part, there is a condition at the beginning, and then six answer options (under the letters from A to F). Participants need to determine whether each of the answer options is correct (fits the problem statement) or incorrect (does not fit the job statement). Each task can have from 0 to 6 correct answers.

### **Grading system:**

For each correctly marked statement, you can get 0.5 points

For each incorrectly marked statement - 0 points

**Task 15 (ID 27) - 3 points**

Common part of the question for all variants:

The picture below shows the fruits of various plants in the Solanaceae family.

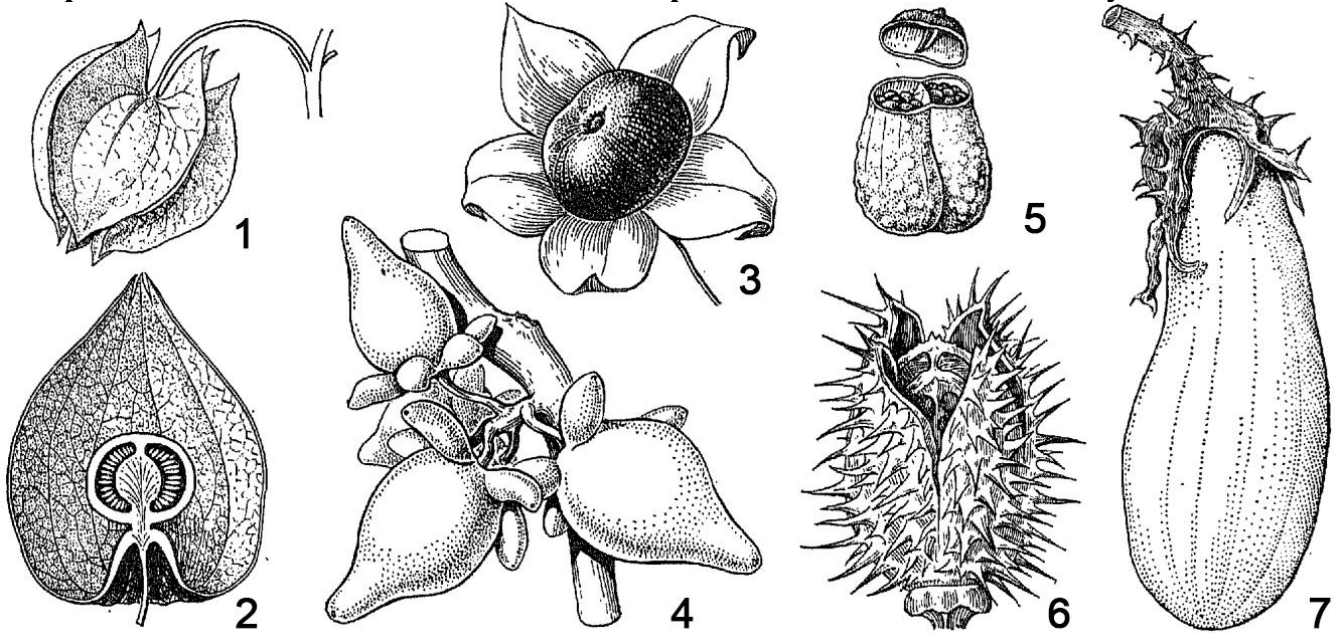

Analyze the picture and indicate for each of the following statements whether it is true or false:

Variant 1:

- A) capsule fruits in the picture are marked as 1, 5 and 6;
- B) fruits of the berry type in the picture are marked as 1, 2, 3, 4, 7;
- C) fruits of the berry type in the picture are marked as 2, 3, 4;
- D) eggplant fruit (*Solanum melongena*) in the picture is marked as 7, type of fruit - pepo;
- E) the fruit of the black henbane (*Hyoscyamus niger*) marked as 5 is a poly-seeded capsule with an opening lid;
- F) the fruit of the papillary nightshade (*Solanum mammosum*) marked as 4 is a single-seeded non-opening capsule;

Variant 2:

- A) capsule fruits in the picture are marked as 5 and 6;
- B) fruits of the berry type in the picture are marked as 1, 2, 3, 4, 7;
- C) blister formation around the *Physalis alkekengi* fruit marked as 2 represents a calyx;
- D) the fruit of the black henbane (*Hyoscyamus niger*) marked as 5 is a poly-seeded capsule with an opening lid;
- E) the fruit of belladonna (*Atropa bella-donna*) marked as 3 is a berry;
- F) the fruit of datura (*Datura stramonium*) marked as 6 is a poly-seeded capsule with an opening lid;

Variant 3:

- A) capsule fruits in the picture are marked as 5 and 6;
- B) fruits of the berry type in the picture are marked as 2, 3, 4;
- C) eggplant fruit (*Solanum melongena*) in the picture is marked as 7, type of fruit - pepo;
- D) the fruit of the black henbane (*Hyoscyamus niger*) marked as 5 is a poly-seeded capsule with an opening lid;
- E) the fruit of belladonna (*Atropa bella-donna*) marked as 3 is a berry;
- F) the fruit of the papillary nightshade (*Solanum mammosum*) marked as 4 is a single-seeded non-opening capsule;

**Task 16 (ID 28) - 3 points**

Common part of the question for all variants:

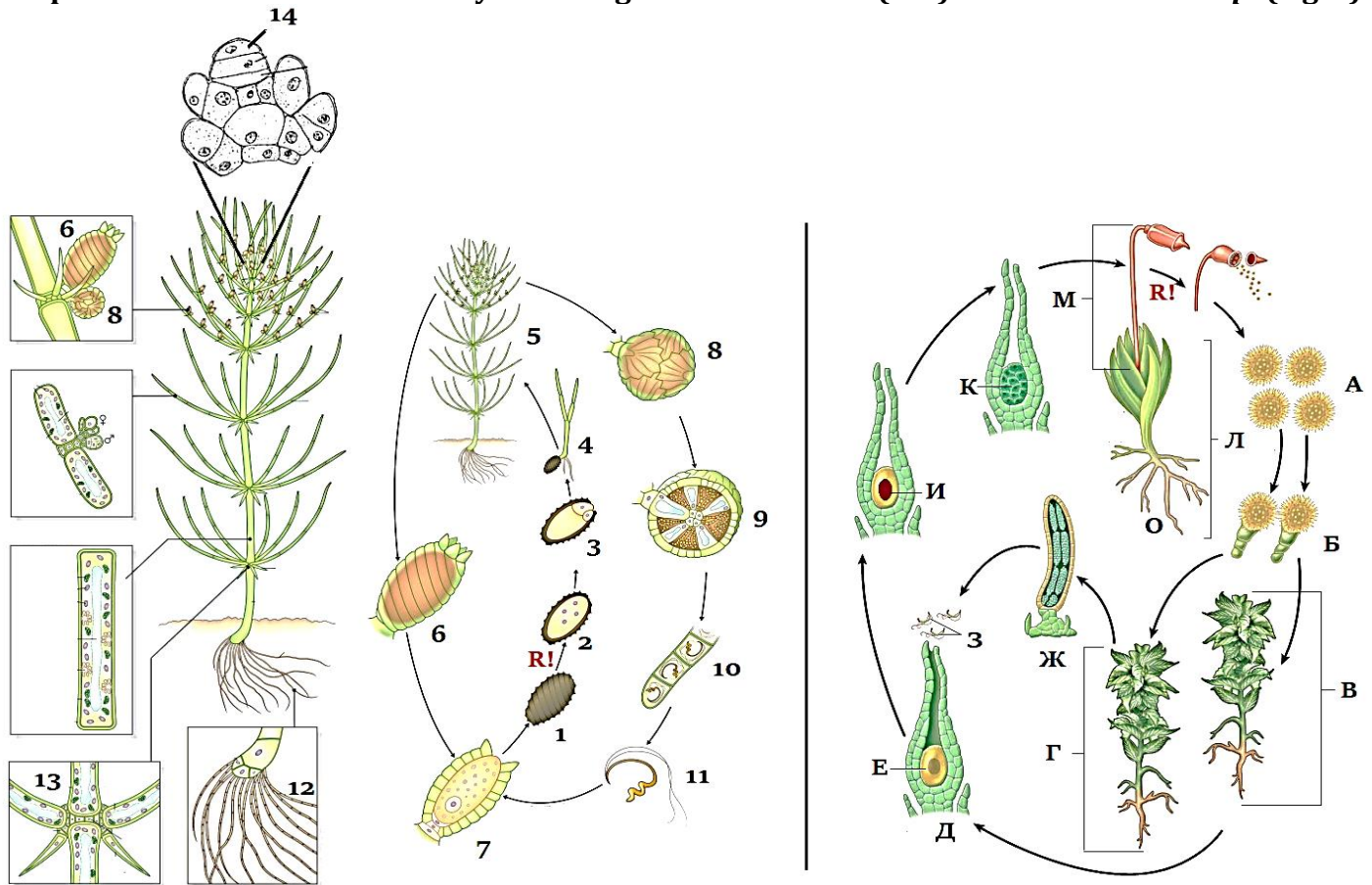
The picture below shows the life cycles of algae *Chara braunii* (left) and moss *Funaria sp.* (right).

Review the picture and specify true or false for each of the following statements:

Variant 1:

- A) in life cycle of *Chara braunii* predominates haplobiont, meiosis occurs immediately after zygote formation;
- B) in life cycle of *Chara braunii* there is an alternation of generations: there are multicellular gametophyte and sporophyte, meiosis before spore formation;
- C) type of sexual process in *Chara braunii* and *Funaria sp.* is oogamy: immobile large female gametes are fertilized by mobile small male gametes;
- D) *Chara braunii* is a monoecious plant because female and male gametangia are on the same organism;
- E) *Funaria sp.* is a dioecious plant because female gametangia are on one plant and male gametangia are on other;
- F) *Funaria sp.* is a monoecious plant because female and male gametangia are on the same organism;

Variant 2:

- A) in life cycle of *Funaria sp.* predominates haplobiont, meiosis occurs immediately after zygote formation;
- B) in life cycle of *Funaria sp.* there is an alternation of generations: there are multicellular gametophyte and sporophyte, meiosis before spore formation;
- C) the type of sexual process in *Chara braunii* and *Funaria sp.* is isogamy: there is a fusion of motile gametes of equal size and identical in morphology;

- D) *Chara braunii* is a monoecious plant because female and male gametangia are on the same organism;
- E) *Chara braunii* is a dioecious plant because female gametangia are on one plant and male gametangia are on other;
- F) *Funaria sp.* is a dioecious plant because female gametangia are on one plant and male gametangia are on other;

*Variant 3:*

- A) in life cycle of *Chara braunii* predominates haplobiont, meiosis occurs immediately after zygote formation;
- B) in life cycle of *Funaria sp.* there is an alternation of generations: there are multicellular gametophyte and sporophyte, meiosis before spore formation;
- C) type of sexual process in *Chara braunii* and *Funaria sp.* is oogamy: immobile large female gametes are fertilized by mobile small male gametes;
- D) *Chara braunii* is a monoecious plant because female and male gametangia are on the same organism;
- E) *Funaria sp.* is a dioecious plant because female gametangia are on one plant and male gametangia are on other;
- F) *Funaria sp.* is a monoecious plant because female and male gametangia are on the same organism;



**Task 17 (ID 29) - 3 points**

Common part of the question for all variants:

Birds have a very complex respiratory system: in addition to the trachea, bronchi and lungs, they have a large number of air sacs - thin-walled cavities that fill space between organs, communicate with lumen of the bronchi, and can contract and expand under the action of the respiratory muscles. All air sacs are divided into two groups - anterior (front) and posterior (back). The main bronchus passes through the body and communicates with the lung, as well as with the posterior and anterior sacs, as shown in the diagram.

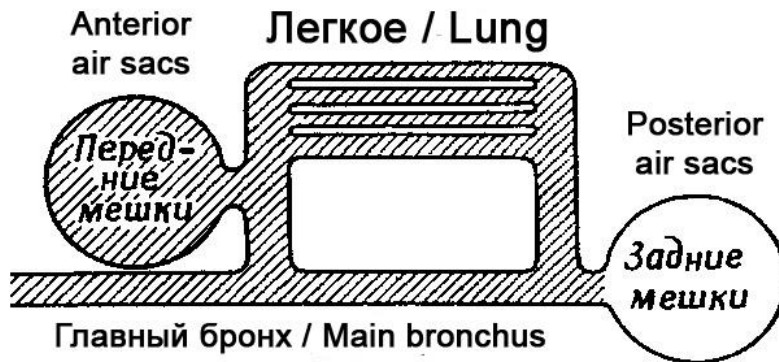

To investigate how air circulation occurs during double breathing in birds, you experimentally obtained the following data:

- 1) Posterior air sacs: oxygen content - 17%, carbon dioxide - 4%;
- 2) Anterior air sacs: oxygen content - 14%, carbon dioxide - 7%;
- 3) If you let the bird breathe in pure oxygen once, then it first of all appears in the posterior air sacs, but on the second breath (the bird already inhales air) this oxygen enters to the anterior air sacs;

Indicate which of the following statements are true or false:

Variant 1:

- A) when inhaling, air enters the anterior air sacs, passes through the lungs and leaves on exhalation through the main bronchus;
- B) when inhaling, air enters the posterior air sacs and lungs; when exhaling, it leaves the posterior air sacs and passes into the lungs; during the second inhalation, it leaves the lungs into the anterior air sacs, and during the second exhalation, from the anterior air sacs outward;
- C) when inhaling, air enters the posterior air sacs, passes through the lungs and leaves on exhalation through the main bronchus;
- D) gas exchange occurs not only in the lungs, but also in the anterior air sacs, therefore, the oxygen content in them decreases, and the carbon dioxide content increases;
- E) gas exchange in birds occurs only in the lungs, but not in the air sacs;
- F) a portion of air travels a full path through the respiratory system in two inhalation-exhalation, and the lungs receive a continuous stream of fresh air through themselves, even on exhalation;

Variant 2:

- A) when inhaling, air enters the posterior air sacs and lungs; when exhaling, it leaves the posterior air sacs and passes into the lungs; during the second inhalation, it leaves the lungs into the anterior air sacs, and during the second exhalation, from the anterior air sacs outward;
- B) when inhaling, air enters the anterior air sacs and lungs; when exhaling, it leaves the anterior air sacs and passes into the lungs; during the second inhalation, it leaves the lungs into the posterior air sacs, and during the second exhalation, from the posterior air sacs outward;
- C) when inhaling, air enters the posterior air sacs, passes through the lungs and leaves on exhalation through the main bronchus;

- D) the posterior air sacs do not take part in breathing, but are only needed to reduce the weight of the bird and increase its flotation when diving underwater for search of prey;
- E) gas exchange in birds occurs only in the lungs, but not in the air sacs;
- F) a portion of air travels a full path through the respiratory system in one inhalation-exhalation, and the lungs receive a continuous flow of fresh air through themselves, even on exhalation;

*Variant 3:*

- A) when inhaling, air enters the posterior air sacs and lungs; when exhaling, it leaves the posterior air sacs and passes into the lungs; during the second inhalation, it leaves the lungs into the anterior air sacs, and during the second exhalation, from the anterior air sacs outward;
- B) when inhaling, air enters the anterior air sacs and lungs; when exhaling, it leaves the anterior air sacs and passes into the lungs; during the second inhalation, it leaves the lungs into the posterior air sacs, and during the second exhalation, from the posterior air sacs outward;
- C) when inhaling, air fills the anterior and posterior air sacs at the same time, and when exhaling, it drives air flows towards each other through the lungs;
- D) gas exchange in birds occurs only in the lungs, but not in the air sacs;
- E) a portion of air travels a full path through the respiratory system in two inhalation-exhalation, and the lungs receive a continuous stream of fresh air through themselves, even on exhalation;
- F) such a structure of the respiratory system allows birds to fly at very high altitudes, where the partial pressure of oxygen is low;



**Task 18 (ID 30) - 3 points**

Common part of the question for all variants:

The picture below shows a diagram of life cycle of *Plasmodium falciparum*.

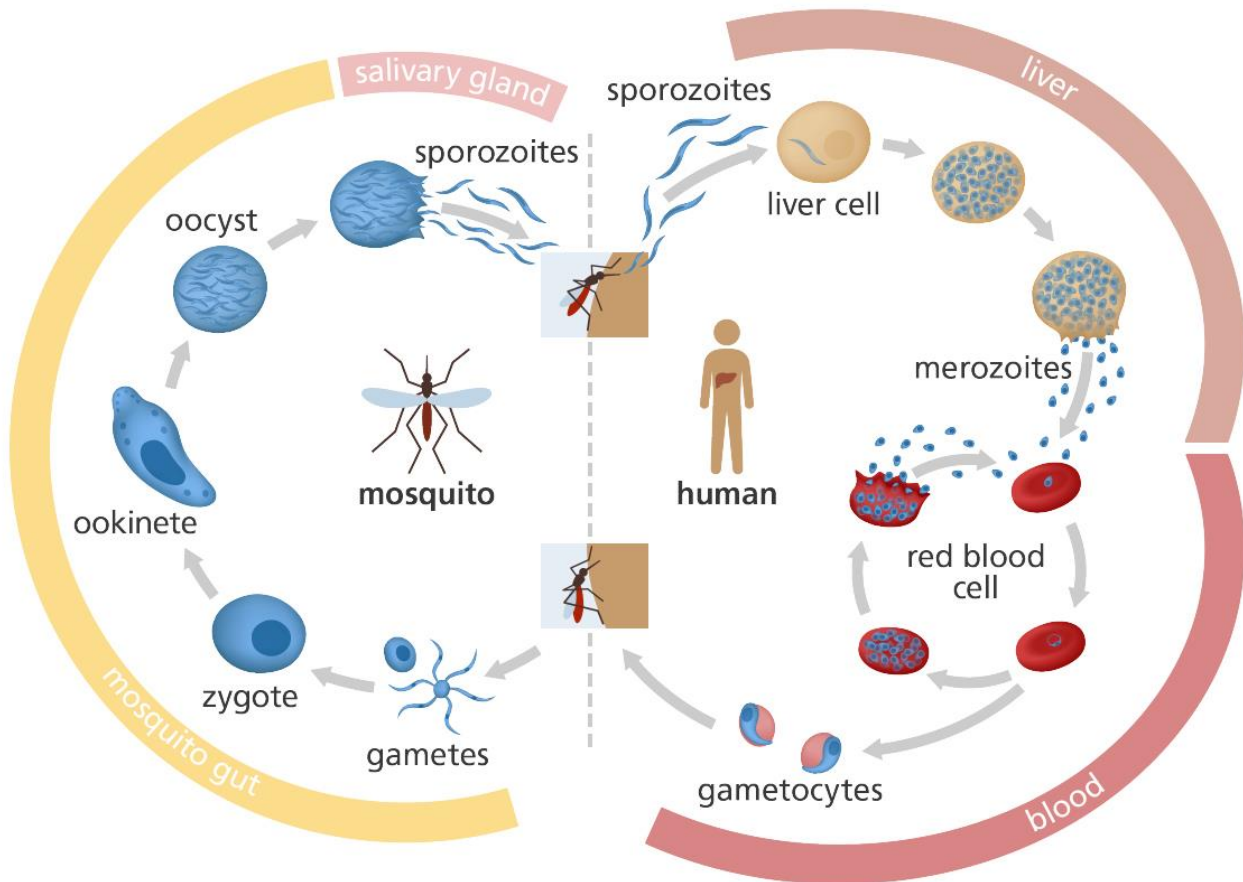

Analyze presented diagram and indicate which of the following statements are true or false:

Variant 1:

- A) sporozoites enter the human blood when bitten by a mosquito and are introduced into erythrocytes;
- B) merozoites are the sexual generation that reproduces in human erythrocytes;
- C) the final host of the parasite is a human, because sexual reproduction of the parasite occurs in the human blood;
- D) ookinete penetrates into intestinal wall of mosquito and undergoes meiotic division, therefore, all other stages of plasmodium carry a haploid set of chromosomes;
- E) ookinete divided by sporogony and forms many sporozoites, which penetrate into salivary glands of mosquito;
- F) during the life cycle, malaria plasmodium multiplies asexually twice - in human liver cells and in oocyte in mosquito intestinal wall;

Variant 2:

- A) sporozoites are able to penetrate into human liver cells and multiply there by schizogony;
- B) merozoites are able to penetrate into human erythrocytes and multiply by schizogony;
- C) the final host of the parasite is a malaria mosquito, because fusion of parasite's gametes occurs in the gut of mosquito;
- D) ookinete divided by sporogony and forms many sporozoites, which penetrate into salivary glands of mosquito;

- E) oocyst and sporozoites are diploid stages and meiosis occurs only at the stage of reproduction in human erythrocytes, when gametocytes are formed;
- F) during the life cycle, malaria plasmodium multiplies asexually three times - in human liver cells and in erythrocytes, in an oocyte in intestinal wall of a mosquito;

*Variant 3:*

- A) sporozoites enter the human blood when bitten by a mosquito and are introduced into erythrocytes;
- B) sporozoites are able to penetrate into human liver cells and multiply there by schizogony;
- C) merozoites are able to penetrate into human erythrocytes and multiply by schizogony;
- D) merozoites are able to form sexual forms - female and male gametocytes, which circulate in human blood;
- E) the final host of the parasite is a malaria mosquito, because fusion of parasite's gametes occurs in the gut of mosquito;
- F) oocyst and sporozoites are diploid stages and meiosis occurs only at the stage of reproduction in human erythrocytes, when gametocytes are formed;

**Task 19 (ID 31) - 3 points**

Common part of the question for all variants:

**Spirometry is the most common of the pulmonary function tests. It measures lung function, specifically the amount (volume) and/or speed (flow) of air that can be inhaled and exhaled. Spirometry is helpful in assessing breathing patterns that identify conditions such as asthma, pulmonary fibrosis, cystic fibrosis and chronic obstructive pulmonary disease. Below is a diagram obtained by spirometry for a healthy patient.**

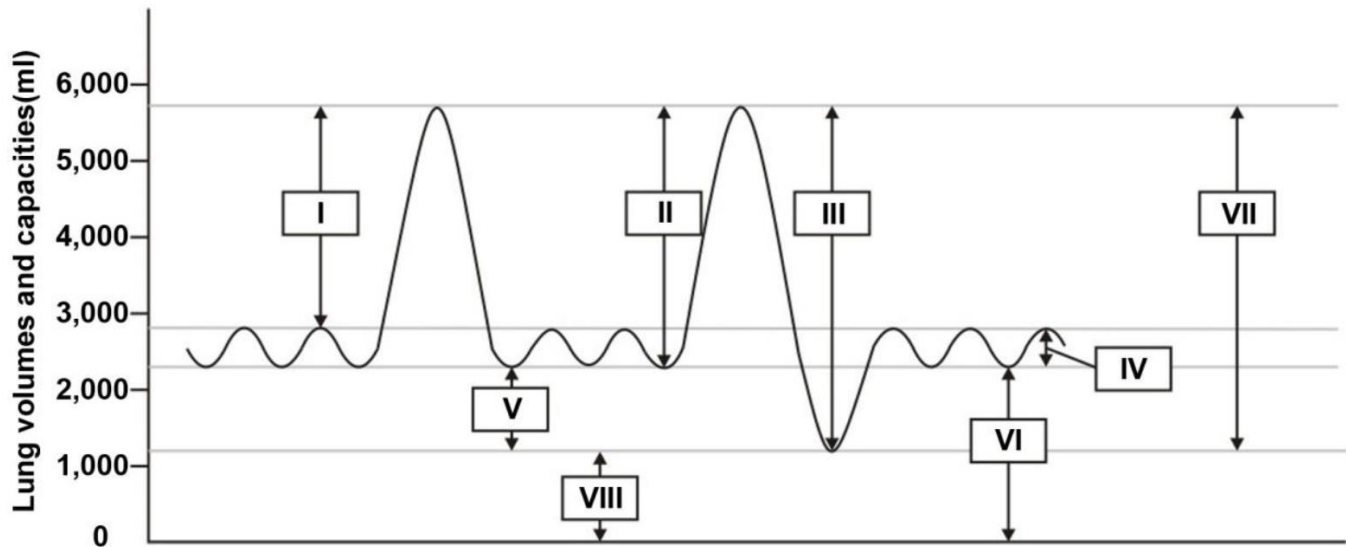

Based on this diagram, indicate which of the following statements are true or false:

Variant 1:

- A) Tidal volume (number IV) - the lung volume representing the normal volume of air displaced between normal inspiration and expiration without extra effort applied;
- B) Total lung capacity (number IV) - the volume of air present in lung after a maximum inspiration;
- C) Expiratory reserve volume (number VI) - amount of air in excess of tidal expiration that can be exhaled with maximum effort;
- D) Vital capacity (number III) - total amount of air flowing between inspiration and expiration at maximal rate, it includes tidal volume, inspiratory reserve volume and expiratory reserve volume;
- E) Inspiratory reserve volume (number I) - the maximum amount of air inhaled over the resting level of spontaneous inspiration;
- F) Residual volume (number VIII) - amount of air in excess of tidal expiration that can be exhaled with maximum effort;

Variant 2:

- A) Tidal volume (number IV) - the lung volume representing the normal volume of air displaced between normal inspiration and expiration without extra effort applied;
- B) Residual volume (number VIII) - the volume of air remaining in lung after a strong forced expiration;
- C) Vital capacity (number III) - total amount of air flowing between inspiration and expiration at maximal rate, it includes tidal volume, inspiratory reserve volume and expiratory reserve volume;
- D) Vital capacity (number VI) - the volume of air present in the lungs, at the end of passive expiration, it is the sum of residual volume and expiratory reserve volume;
- E) Inspiratory capacity (number II) - the maximum volume of air inhaled in a normal inspiration, it comprises tidal volume and inspiratory reserve;
- F) Expiratory reserve volume (number V) - amount of air in excess of tidal expiration that can be exhaled with maximum effort;

*Variant 3:*

- A) Total lung capacity (number IV) – the volume of air present in lung after a maximum inspiration;
- B) Residual volume (number VIII) – the volume of air remaining in lung after a strong forced expiration;
- C) Expiratory reserve volume (number VI) – amount of air in excess of tidal expiration that can be exhaled with maximum effort;
- D) Vital capacity (number VI) – the volume of air present in the lungs, at the end of passive expiration, it is the sum of residual volume and expiratory reserve volume;
- E) Residual volume (number VIII) – amount of air in excess of tidal expiration that can be exhaled with maximum effort;
- F) Inspiratory capacity (number II) - the maximum volume of air inhaled in a normal inspiration, it comprises tidal volume and inspiratory reserve;

**Task 20 (ID 32) - 3 points**

Common part of the question for all variants:

The figure below shows some of the internal organs of human.

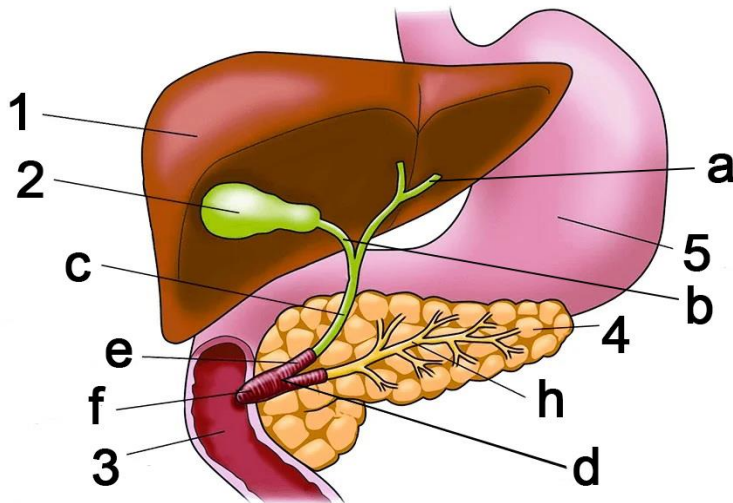

Based on this picture, indicate which of the following statements are true or false:

*Variant 1:*

- A) hormone cholecystikinin acts only on organs 2 and 4;
- B) organ designated as 1 is capable of synthesizing the following proteins: serum albumin, angiotensin, fibrinogen;
- C) structure marked by letter "a" in the figure is called the ureter;
- D) structure marked by letter "h" in the figure is called the pancreatic duct;
- E) organ designated as 4 is capable for synthesizing the following enzymes: lactase, pepsin;
- F) organ designated as 4 synthesizes insulin, which increases the absorption of glucose by adipose tissue and muscles, and also reduces ketogenesis in the organ designated as 1;

*Variant 2:*

- A) hormone cholecystikinin acts only on organs 3 and 5;
- B) organ designated as 1 is able to synthesize the following proteins: renin, growth hormone, vasopressin, glucagon;
- C) structure marked by letter "c" in the figure is called the common bile duct;
- D) organ designated as 4 is capable for synthesizing the following enzymes: nucleases, lipases, trypsinogen, chymotrypsinogen;
- E) organ designated as 4 is capable for synthesizing the following enzymes: lactase, pepsin;
- F) organ designated as 4 synthesizes insulin, which reduces the absorption of glucose by adipose tissue and muscles, and also reduces the synthesis of lipids in the organ designated as 1;

*Variant 3:*

- A) hormone cholecystikinin acts only on organs 2 and 4;
- B) organ designated as 1 is able to synthesize the following proteins: renin, growth hormone, vasopressin, glucagon;
- C) structure marked by letter "c" in the figure is called the common bile duct;
- D) structure marked by letter "h" in the figure is called the pancreatic duct;
- E) organ designated as 4 is capable for synthesizing the following enzymes: nucleases, lipases, trypsinogen, chymotrypsinogen;
- F) organ designated as 4 synthesizes insulin, which increases the absorption of glucose by adipose tissue and muscles, and also reduces ketogenesis in the organ designated as 1;

**Task 21 (ID 33) – 3 points**

Common part of the question for all variants:

A group of students studied the topic "Structure of carbohydrates". At the lecture, they learned that monosaccharides can exist in solution in an open chain form (Fischer projections) and in a closed ring form (Haworth structures). In the textbook, they found instructions on how to get the ring formula from the chain formula of D-glucose.

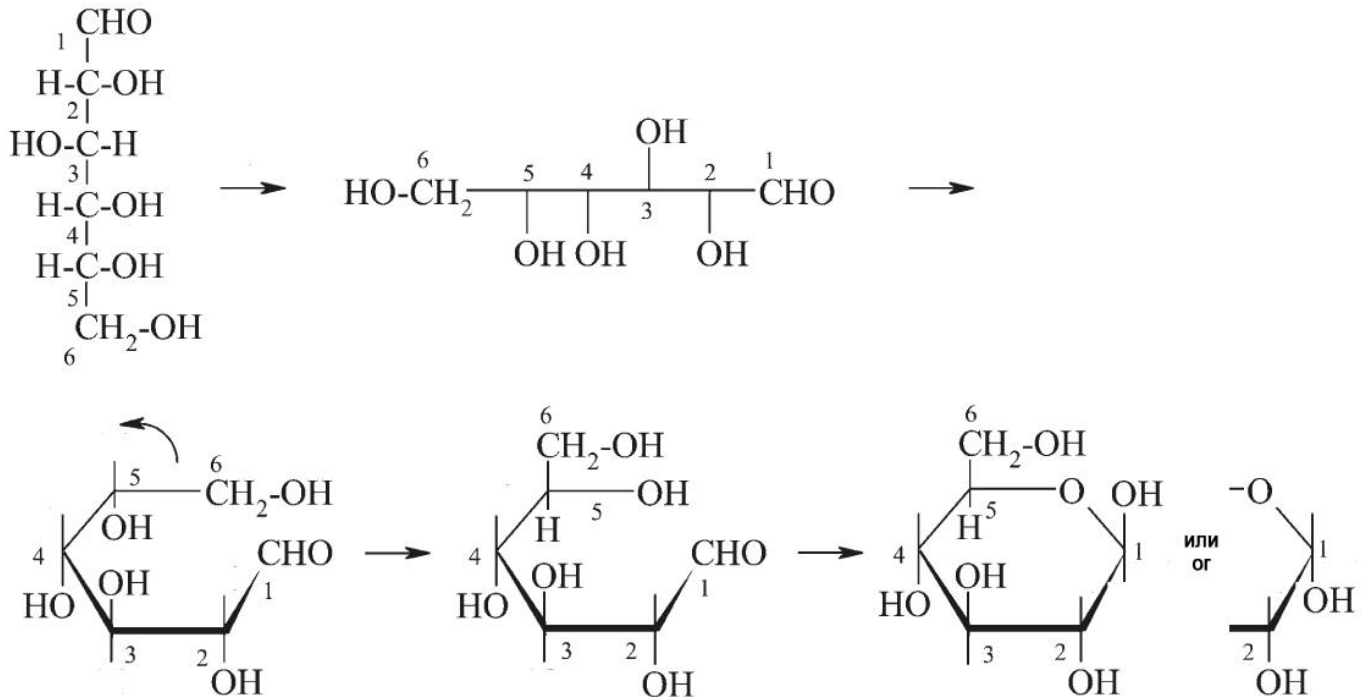

The students decided to practice converting D-mannose from chain to ring. In total, they got five different formulas:

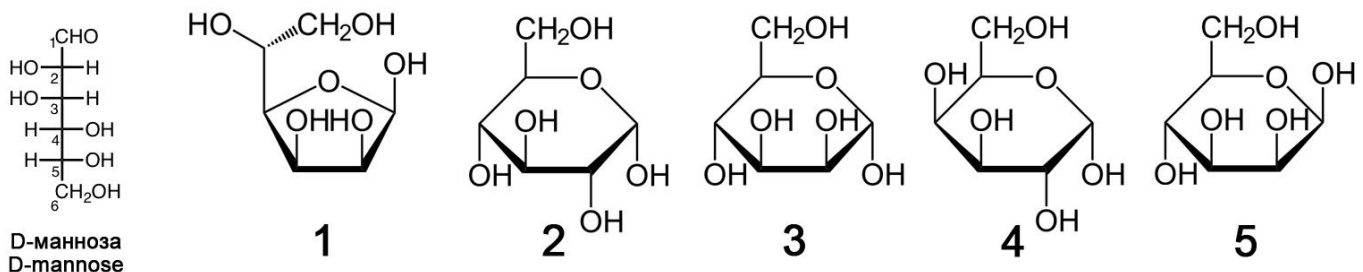

Analyze the formulas and specify true or false for each of the following statements:

Variant 1:

- A) all five formulas created by the students are not mannose formulas;
- B) formula 1 is incorrect, because only six atoms can form a ring, but not five atoms as in this formula;
- C) formula 2 is a glucose, the error is that the OH group on the second carbon atom is incorrectly oriented;
- D) formula 3 is the formula for mannose in alpha orientation of OH group at first carbon atom;
- E) formula 4 is the formula for mannose in furanose form (five atoms in ring) and not in pyranose form;
- F) formula 5 is the formula for fructose, a monosaccharide found in sucrose;

Variant 2:

- A) mannose is represented by formulas 2, 3 and 4, but formulas 1 and 5 are other carbohydrates;
- B) formula 1 represents mannose in furanose form (five atoms in ring);

- C) formula 2 is the mannose formula in L-form, not D-form;
- D) formula 3 is the formula of lyxose, a disaccharide found in blood of insects;
- E) formula 4 is the formula for galactose, a monosaccharide found in lactose;
- F) formula 5 is the formula for mannose in beta orientation of OH group at first carbon atom;

*Variant 3:*

- A) mannose is represented by formulas 1, 3 and 5, but formulas 2 and 4 are other carbohydrates;
- B) formula 1 represents mannose in furanose form (five atoms in ring);
- C) formula 2 is the mannose formula in L-form, not D-form;
- D) formula 3 is the formula for mannose in alpha orientation of OH group at first carbon atom;
- E) formula 4 is the formula for galactose, a monosaccharide found in lactose;
- F) formula 5 is the formula for fructose, a monosaccharide found in sucrose;



**Task 22 (ID 36) – 3 points**

Common part of the question for all variants:

On August 11, 2020, the first vaccine against SARS-CoV-2 virus was registered in Russia. This vaccine based on technology using human adenoviruses. They deliver S-protein into human cells. S-protein is a surface protein of coronavirus responsible for binding to a receptor (angiotensin converting enzyme 2) on surface of human cells. An approximate diagram describing process of formation of immunity in response to this vaccine is shown below.

# Sputnik V

THE FIRST REGISTERED COVID-19 VACCINE  
PROVEN HUMAN ADENOVIRAL VECTOR TECHNOLOGY

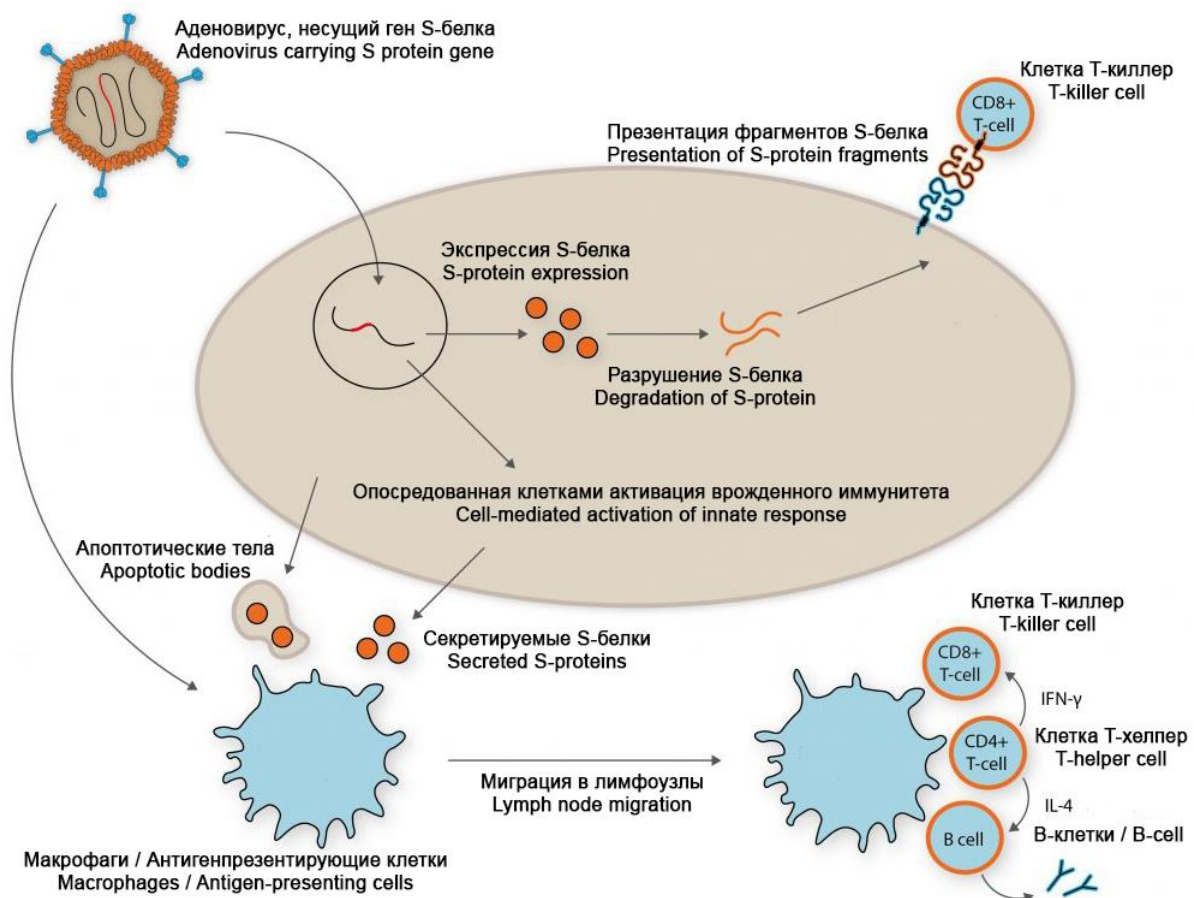

Analyze presented scheme and determine which of the statements are true or false:

Variant 1:

- A) this vaccine does not use SARS-CoV-2 virus, so there is no risk of COVID-19 infection for patients;
- B) modified adenoviruses are used in this vaccine to transfer (deliver) a gene encoding surface S-protein of SARS-CoV-2 virus into human cells;
- C) surface S-protein of SARS-CoV-2 virus is expressed after entry of adenovirus into human cell;
- D) the cell can present S-protein to T-killers (CD8<sup>+</sup> T-cell), which causes activation of cellular antiviral systems and/or apoptosis;
- E) S-protein secreted by cells and apoptotic bodies can enter macrophages and antigen-presenting cells;
- F) macrophages and antigen-presenting cells activate T-helpers (CD4<sup>+</sup> T-cell), which further activate T-killers (CD8<sup>+</sup> T-cell) and B-lymphocytes, which leads to formation of cellular and humoral immunity;



*Variant 2:*

- A) this vaccine uses an inactivated (killed) SARS-CoV-2 virus, therefore, COVID-19 infection is possible if virus is not completely inactivated during manufacture of vaccine;
- B) modified adenoviruses are used in this vaccine to transfer (deliver) a gene encoding surface S-protein of SARS-CoV-2 virus into human cells;
- C) modified adenoviruses cause COVID-19 in humans;
- D) macrophages and antigen-presenting cells activate T-helpers (CD4<sup>+</sup> T-cell), which further activate T-killers (CD8<sup>+</sup> T-cell) and B-lymphocytes, which leads to formation of cellular and humoral immunity;
- E) B-lymphocytes are needed to develop cellular immunity and destroy all cells infected with adenovirus and coronavirus (with subsequent infection);
- F) main advantage of this vaccine is that it leads to formation of humoral (antibodies) and cellular (T-cells) immunity to S-protein of SARS-CoV-2 virus;

*Variant 3:*

- A) this vaccine does not use SARS-CoV-2 virus, so there is no risk of COVID-19 infection for patients;
- B) modified adenoviruses are harmless to humans;
- C) the cell can present S-protein to T-killers (CD8<sup>+</sup> T-cell), which causes activation of cellular antiviral systems and/or apoptosis;
- D) macrophages and antigen-presenting cells activate T-helpers (CD4<sup>+</sup> T-cell), which further activate T-killers (CD8<sup>+</sup> T-cell) and B-lymphocytes, which leads to formation of cellular and humoral immunity;
- E) certain B-lymphocytes are capable of producing antibodies that bind to S-protein of SARS-CoV-2 virus;
- F) this vaccine only leads to production of antibodies to S-protein of SARS-CoV-2 virus, but does not lead to formation of memory T-cells and T-killers (CD8 + T-cell), which can kill cells infected by SARS-CoV-2;

**Task 23 (ID 37) – 3 points**

*Common part of the question for all variants:*

**In maize a single locus determines the color of the seed; allele «A» results in colored seeds, and allele «a» in colorless seeds. Another locus determines the shape of the seeds; allele «B» results in a smooth shape of the seeds, and «b» in wrinkled seeds.**

**In a crossbreeding between the plant that grew from a colored and smooth seed and the plant that grew from a colorless and wrinkled seed, the offspring were documented as:**

**376 had colored and smooth seeds;**

**13 had colored and wrinkled seeds;**

**13 had colorless and smooth seeds;**

**373 had colorless and wrinkled seeds;**

**This experiment 1 made it possible to establish the genotypes of the parent plants and the frequency of occurrence of recombinants.**

**In addition, maize has three other loci: «C», «D» and «E», which are located on the same chromosome in this order. Using similar experiments 2 to the above, we found that the frequency of recombinants between «C» and «D» is 10% and that between «D» and «E» it is 20%. For each of the following statements regarding the results of two described experiments, indicate whether it is true or false:**

*Variant 1:*

A) genotypes of the parent plants in experiment 1 were: AABb x aaBb;

B) genotypes of the parent plants in experiment 1 were: AaBb x aabb;

C) frequency of recombinants in experiment 1 is: 0.335%;

D) frequency of recombinants in experiment 1 is: 1.68%;

E) assuming that crossing over occurs randomly on the chromosome, expected frequency of recombination between «C» and «E» in experiment 2 is: 26%;

F) assuming that crossing over occurs randomly on the chromosome, expected frequency of recombination between «C» and «E» in experiment 2 is: 30%;

*Variant 2:*

A) genotypes of the parent plants in experiment 1 were: AaBb x aabb;

B) genotypes of the parent plants in experiment 1 were: AABb x aaBB;

C) frequency of recombinants in experiment 1 is: 3.35%;

D) frequency of recombinants in experiment 1 is: 6.91%;

E) assuming that crossing over occurs randomly on the chromosome, expected frequency of recombination between «C» and «E» in experiment 2 is: 26%;

F) assuming that crossing over occurs randomly in the chromosome, expected frequency of recombination between «C» and «E» in experiment 2 is: 34%;

*Variant 3:*

A) genotypes of the parent plants in experiment 1 were: AaBb x aabb;

B) genotypes of the parent plants in experiment 1 were: aabb x AABB;

C) frequency of recombinants in experiment 1 is: 0.335%;

D) frequency of recombinants in experiment 1 is: 3.35%;

E) assuming that crossing over occurs randomly on the chromosome, expected frequency of recombination between «C» and «E» in experiment 2 is: 30%;

F) assuming that crossing over occurs randomly on the chromosome, expected frequency of recombination between «C» and «E» in experiment 2 is: 2%;

**Task 24 (ID 39) - 3 points**

Common part of the question for all variants:

In an old evolutionary textbook, you found a figure of an evolutionary tree.

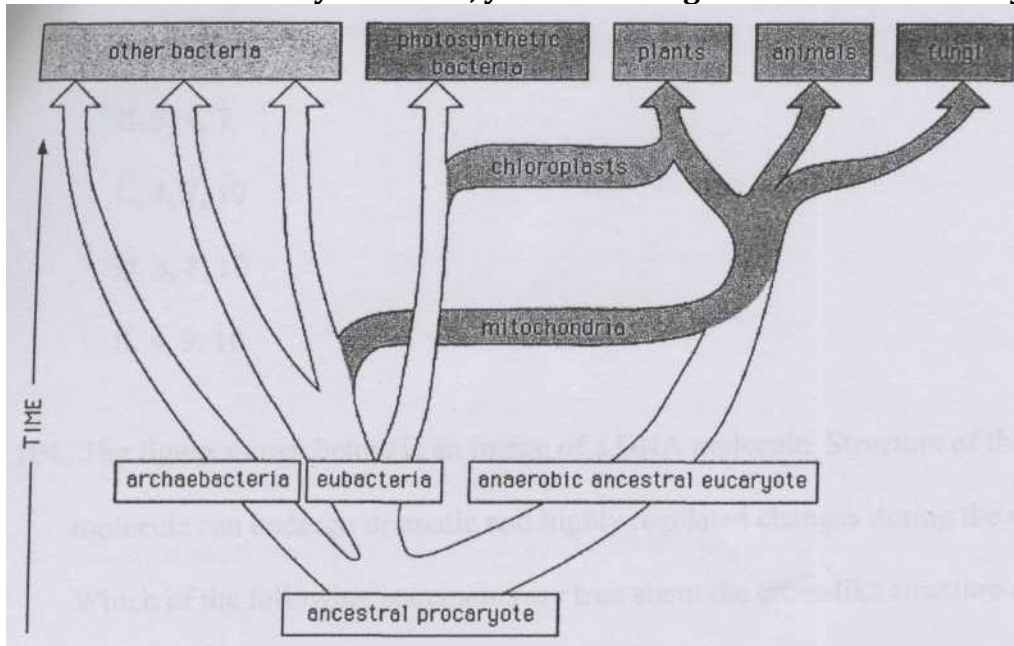

Which of the following statements about evolution are true and deducible from the figure?

Variant 1:

- A) All eucaryotic cells contain mitochondria.
- B) Symbiosis of the eucaryotic ancestor with autotrophic cells preceded the symbiosis with the cell taking advantage of the oxidative metabolism.
- C) The ancestral eucaryote was anaerobic.
- D) Mitochondria and chloroplasts have similar genomes.
- E) Fungi lost chloroplasts during evolution.
- F) Bacteria are a highly homogenous group of organisms, which showed rapid diversification of their genomes and metabolisms during the last billion years.

Variant 2:

- A) All eucaryotic cells contain mitochondria.
- B) There is a common ancestor of eubacteria and eukaryota, archaeobacteria are a group with unique and independent origin.
- C) The ancestral eucaryote was anaerobic.
- D) None of the recent photosynthetic bacteria are related to the chloroplasts.
- E) Mitochondria are present in the cells of the plants, animals and fungi.
- F) Chloroplasts and mitochondria are results of independent endosymbiotic events.

Variant 3:

- A) Symbiosis of the eucaryotic ancestor with autotrophic cells preceded the symbiosis with the cell taking advantage of the oxidative metabolism.
- B) There is a common ancestor of eubacteria and eukaryota, archaeobacteria are a group with unique and independent origin.
- C) None of the recent photosynthetic bacteria are related to the chloroplasts.
- D) Mitochondria and chloroplasts have similar genomes.
- E) Bacteria are a highly homogenous group of organisms, which showed rapid diversification of their genomes and metabolisms during the last billion years.
- F) Chloroplasts and mitochondria are results of independent endosymbiotic events.

## **Part C: Matching Questions**

In the tasks of this part, the participants need to analyze various photographs, drawings, diagrams (marked with Arabic numerals) and compare them with elements from the two lists below (marked with Latin letters and Roman numerals). As an answer in each task, the participants must draw arrows between the elements being compared.

### **Grading system:**

For each correctly indicated match between elements of 1 and 2 rows or 1 and 3 rows, the participant receives 0.5 points.

For each incorrect match - 0 points.

**Task 25 (ID 40) - 5 points***Variant 1*

Nikolai Vavilov is a russian geneticist, botanist and agronomist. He organized and headed several botanical and agronomic expeditions, covering most of the continents, in which he discovered ancient centers of origin of cultivated plants. Based on these materials, he created hypothesis about the world centers of origin of cultivated plants. He identified seven such centers (see map and list below).



The task contains five photographs of cultivated plants, you need to correctly compare these plants with the proposed names and centers of origin (according to N. Vavilov):

1



2



3



4



5



**List of plant names (this list is redundant - it contains unnecessary names):**

- A) Pineapple (*Ananas comosus*);
- B) Cinchona (*Cinchona* sp.);
- C) Coffee tree (*Coffea* sp.);
- D) Buckwheat (*Fagopyrum* sp.);
- E) Flax (*Linum* sp.);
- F) Olive tree (*Olea europaea*);
- G) Sugarcane (*Saccharum officinarum*);
- H) Rye (*Secale cereale*);
- I) Cocoa (*Theobroma cacao*);

J) Corn (*Zea mays*);

**List of centers of origin of cultivated plants (this list is redundant):**

- I) Central American (Mexico, Central America);
- II) South American (Peru, Ecuador, Bolivia);
- III) Mediterranean;
- IV) West Asian (Lebanon, Israel, Syria, Iraq);
- V) Abyssinian (Sudan, Eritrea);
- VI) Central Asian (Pakistan, Afghanistan, Turkmenistan);
- VII) Indian and Indo-Malay;
- VIII) East Asia Center (Chinese);



**Task 25 (ID 40) - 5 points**

Variant 2

Nikolai Vavilov is a russian geneticist, botanist and agronomist. He organized and headed several botanical and agronomic expeditions, covering most of the continents, in which he discovered ancient centers of origin of cultivated plants. Based on these materials, he created hypothesis about the world centers of origin of cultivated plants. He identified seven such centers (see map and list below).



The task contains five photographs of cultivated plants, you need to correctly compare these plants with the proposed names and centers of origin (according to N. Vavilov):



**List of plant names (this list is redundant - it contains unnecessary names):**

- A) Pineapple (*Ananas comosus*);
- B) Cinchona (*Cinchona* sp.);
- C) Coffee tree (*Coffea* sp.);
- D) Buckwheat (*Fagopyrum* sp.);
- E) Flax (*Linum* sp.);
- F) Olive tree (*Olea europaea*);
- G) Sugarcane (*Saccharum officinarum*);
- H) Rye (*Secale cereale*);
- I) Cocoa (*Theobroma cacao*);

J) Corn (*Zea mays*);

**List of centers of origin of cultivated plants (this list is redundant):**

- I) Central American (Mexico, Central America);
- II) South American (Peru, Ecuador, Bolivia);
- III) Mediterranean;
- IV) West Asian (Lebanon, Israel, Syria, Iraq);
- V) Abyssinian (Sudan, Eritrea);
- VI) Central Asian (Pakistan, Afghanistan, Turkmenistan);
- VII) Indian and Indo-Malay;
- VIII) East Asia Center (Chinese);



**Task 26 (ID 41) - 5 points**

Variant 1

You need to compare the juvenile and imaginal forms of various animals and choose a special term that denotes the juvenile form of animal shown on photo.

Juvenile forms:

1



2



3



4



5



Imaginal forms:

A



B



C



D



E



List of juvenile form names (the list is redundant - there are extra names):

- I) Axolotl;
- II) Cub;
- III) Chrysalis;
- IV) Miracidium;

- V) Nauplius;
- VI) Nymph;
- VII) Sandworm;
- VIII) Polyp, strobe;

**Task 26 (ID 41) - 5 points**

Variant 2

You need to compare the juvenile and imaginal forms of various animals and choose a special term that denotes the juvenile form of animal shown on photo.

Juvenile forms:

1



2



3



4



5



Imaginal forms:

A



B

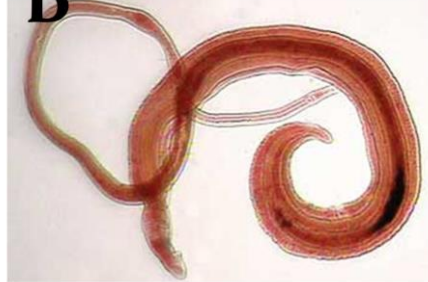

C



D



E



List of juvenile form names (the list is redundant - there are extra names):

- I) Axolotl;
- II) Cub;
- III) Chrysalis;
- IV) Miracidium;

- V) Nauplius;
- VI) Nymph;
- VII) Sandworm;
- VIII) Polyp, strobe;



**Task 27 (ID 42) - 5 points***Variant 1*

Before the introduction of photography into everyday life, people painted to preserve visual images. Including on a medical topic. Further, there are medical illustrations and works of fine art, displaying directly or in metaphorical form the symptoms of certain diseases, or methods of treatment.

In this task, you will need to match the illustrations with names of diseases and with facts about diseases.

**List of diseases (the list is redundant - it contains unnecessary terms):**

- A) Diphtheria;
- B) Goiter;
- C) Smallpox;
- D) Gout;
- E) Polio;
- F) Leprosy;
- G) Syphilis;
- H) Tuberculosis;
- I) Scurvy;
- J) Elephantiasis;

**List of Disease Facts:**

- I) Patients used iron lungs to relieve symptoms;
- II) King Baldwin IV of Jerusalem suffered from this disease;
- III) From this died: Chekhov, Kafka, Belinsky, Makhno, Oruel, Kustodiev, Chopin, Schrödinger, Spinoza, Jane Austen, Louis XVII and the heroes of literary works "Lady with Camellias", "Three comrades", "Magic Mountain";
- IV) The last case of infection was registered in 1977;
- V) When it enters the human body, the pathogen settles in the lymph nodes;

**Task 27 (ID 42) - 5 points***Variant 2*

Before the introduction of photography into everyday life, people painted to preserve visual images. Including on a medical topic. Further, there are medical illustrations and works of fine art, displaying directly or in metaphorical form the symptoms of certain diseases, or methods of treatment.

In this task, you will need to match the illustrations with names of diseases and with facts about diseases.

1

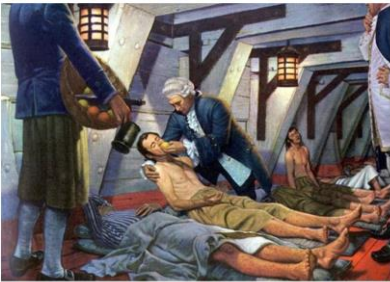

2



3



4

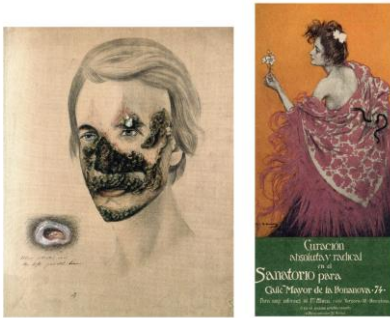

5

**List of diseases (the list is redundant - it contains unnecessary terms):**

- A) Diphtheria;
- B) Goiter;
- C) Smallpox;
- D) Gout;
- E) Polio;
- F) Leprosy;
- G) Syphilis;
- H) Tuberculosis;
- I) Scurvy;
- J) Elephantiasis;

**List of Disease Facts:**

- I) The pathogen releases a toxin that inactivates the translation elongation factor eEF-2;
- II) To prevent this disease, it is recommended to use seaweed, walnuts, persimmon;
- III) The drug - allopurinol - inhibits xanthine oxidase;
- IV) Pyrotherapy helps against this disease, earlier for this patient were infected with malaria;
- V) Among mammals, only primates and guinea pigs are susceptible to this disease;

**Task 28 (ID 43) - 5 points***Variant 1*

The pictures show the chemical formulas of various substances, images of organisms from which they are obtained, as well as images showing the use of this substance in various fields of human activity.

In this task, you need to determine the name of the substance in each of the pictures and compare it with the areas and methods of application given in the list.

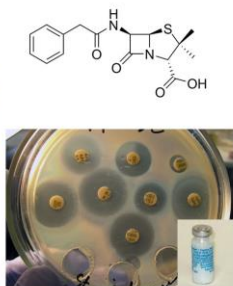
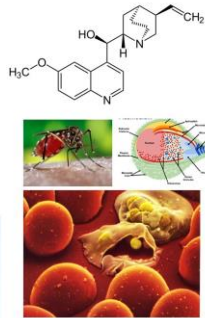
**1****2****3****4****5**

**List of names of substances (the list is redundant - it contains unnecessary terms):**

- A) Agarose;
- B) Atropine;
- C) Capsaicin;
- D) Colchicine;
- E) Caffeine;
- F) Menthol;
- G) Penicillin;
- H) Natural (isoprene) rubber;
- I) Sucrose;
- J) Quinine;

**List of areas and methods of application of these substances:**

- I) Acetylcholine receptor blocker;
- II) Waterproof material, good dielectric, natural elastomer;
- III) Antipyretic, analgesic, antimalarial action;
- IV) Used in the industrial production of edible sugar;
- V) Cure for bacterial infection;



**Task 28 (ID 43) - 5 points**

Variant 2

The pictures show the chemical formulas of various substances, images of organisms from which they are obtained, as well as images showing the use of this substance in various fields of human activity.

In this task, you need to determine the name of the substance in each of the pictures and compare it with the areas and methods of application given in the list.

**1**



**2**



**3**



**4**



**5**



**List of names of substances (the list is redundant - it contains unnecessary terms):**

- A) Agarose;
- B) Atropine;
- C) Capsaicin;
- D) Colchicine;
- E) Caffeine;
- F) Menthol;
- G) Penicillin;
- H) Natural (isoprene) rubber;
- I) Sucrose;
- J) Quinine;

**List of areas and methods of application of these substances:**

- I) Local anesthetic, stimulates cold receptors, essential nutritional supplement for flavoring;
- II) Mutagen, blocks the formation of a fission spindle;
- III) Psychostimulant, essential nutritional supplement;
- IV) Natural irritant, pain reliever;
- V) Formation of gels, added to the nutrient medium to make it hard;



**Task 29 (ID 44) - 5 points****Вариант 1**

The cells of multicellular organisms in the process of development and differentiation form a huge variety of tissues. Modern histology distinguishes about 230 different types of human cells, differing in structure and function.

This task contains micrographs of different types of human cells. You need to determine the name of cell type shown in each micrograph and correlate this cell type with a suitable functional characteristic from the list.

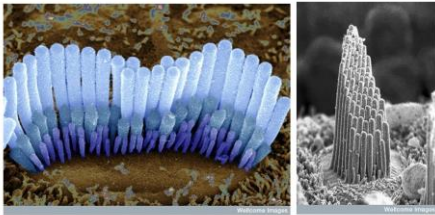
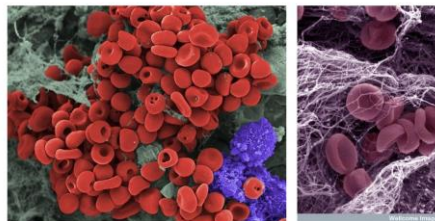
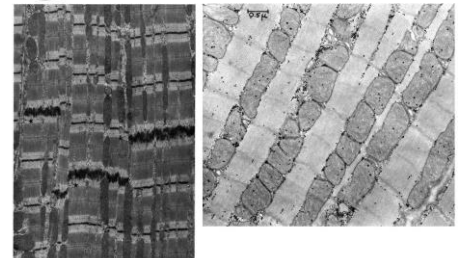
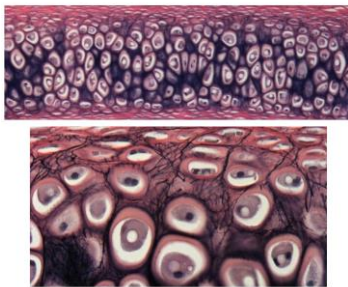
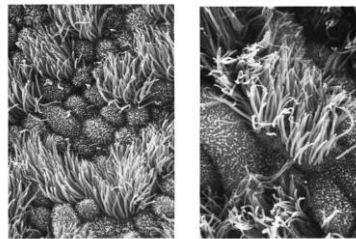
**1****2****3****4****5****List of cell types (the list is redundant - it contains unnecessary terms):**

- A) Inner ear hair cells;
- B) Cardiomyocytes;
- C) Ciliated epithelial cells;
- D) Macrophages;
- E) Neurons;
- F) Rods and cones;
- G) Sperm;
- H) Mast cells;
- I) Chondrocytes;
- J) Erythrocytes;

**Feature list:**

- I) The cells are ectodermal in origin and line the airways. The cells are completely submerged in mucus. The outgrowths of cells perform oscillatory movements and move the mucous membrane along the airways to the external environment;
- II) The cells are elongated and have longitudinally located myofibrils and myofilaments. Subtypes are distinguished: working (contractile), sinus (pacemaker), transitional, conducting, secretory;
- III) The main function is the synthesis and isolation of the components of the intercellular substance, which forms an amorphous substance and fibrous structures. By isolating the components of the intercellular substance, these cells walled themselves up in specific cavities – lacunae;
- IV) Very small elastic disc-shaped biconcave cells with a diameter of 7 to 10 microns. They lack the cell nucleus and most organelles, which increases the concentration of hemoglobin;

- V) They are located in the organ of Corti on a thin basilar membrane in a channel filled with fluid. They got their name from the filaments of stereocilia that are located on the top surface of the cell;

**Task 29 (ID 44) - 5 points**

Variant 2

The cells of multicellular organisms in the process of development and differentiation form a huge variety of tissues. Modern histology distinguishes about 230 different types of human cells, differing in structure and function.

This task contains micrographs of different types of human cells. You need to determine the name of cell type shown in each micrograph and correlate this cell type with a suitable functional characteristic from the list.

1

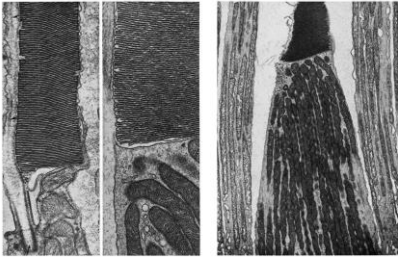

2

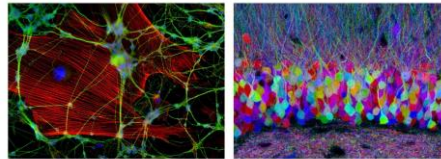

3

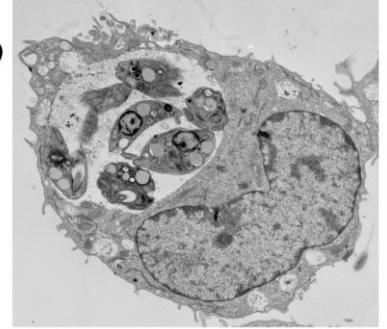

4

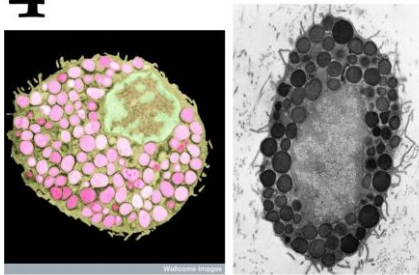

5

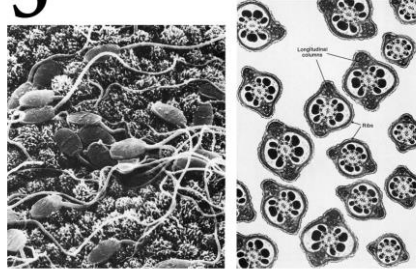
**List of cell types (the list is redundant - it contains unnecessary terms):**

- A) Inner ear hair cells;
- B) Cardiomyocytes;
- C) Ciliated epithelial cells;
- D) Macrophages;
- E) Neurons;
- F) Rods and cones;
- G) Sperm;
- H) Mast cells;
- I) Chondrocytes;
- J) Erythrocytes;

**Feature list:**

- I) Cells usually have the ability to actively move and serve for fertilization. They usually do not contain a significant amount of cytoplasm and are produced simultaneously in large quantities;
- II) The cells are contained in the outer granular layer of the retina. Cells respond with hyperpolarization when exposed to light;
- III) Cells capable of actively capturing and digesting bacteria, the remains of dead cells and other particles that are foreign or toxic to the body. They originate from the erythromyeloid precursors of the yolk sac and embryonic liver or short-lived agranular leukocytes;
- IV) One of the types of granulocytes, which in a mature state are incorporated into connective tissues, are also part of the neuroimmune system. They play an important role in allergic reactions;

- V) An electrically excitable cell that processes, stores, and transmits information using electrical and chemical signals. The cell contains the nucleus, cell body, and branches;