

Phystech.International Olympiad in Biology
2021/22 academic year
Qualifying stage



ANSWERS TO TASKS FOR PRE-GRADUATING LEVEL

The Olympiad tasks are divided into three parts:

Part A: Tasks with one correct answer (23 tasks and 29 points in total)

Part B: Multiple Choice Questions (15 tasks and 45 points in total)

Part C: Matching Questions (8 tasks and 40 points in total)

Total: 114 points

Part A: Tasks with one correct answer

In all the tasks of this part, there is a condition at the beginning, and then four answer options (under the letters from A to D). Participants need to determine which one of the answer options is correct (fits the wording of the task). Each task can have only one correct answer. For each question, the number of points for the correct answer is indicated: there are two costs - 1 point each and 2 points each.

Grading system:

For each correct answer - 1 or 2 points

For each wrong answer - 0 points

Correct answers are underlined

Task ID 1 – 1 point

Common part of the question for all variants:

Look at the scheme of the saw cut of oak (*Quercus longipes*) trunk.

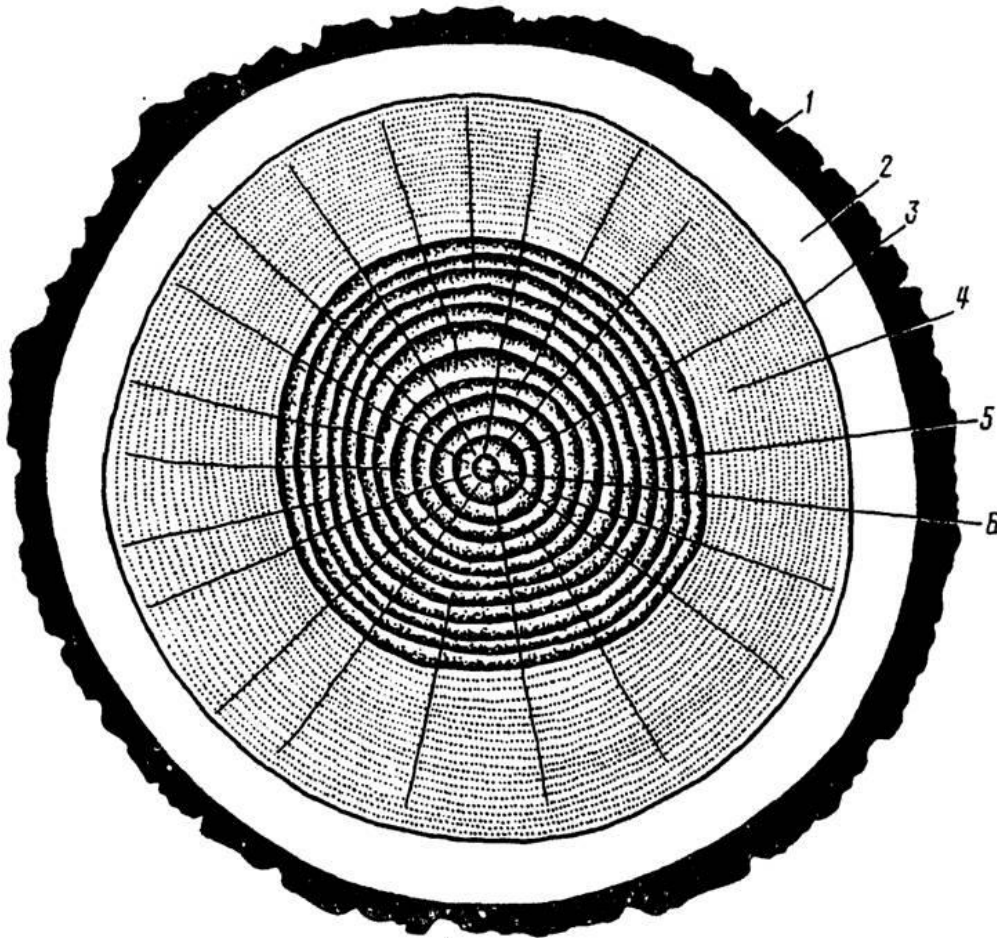

Legend:

1 - hard bark,

2 - soft bark,

3 - cambium,

4 - sapwood,

5 - heartwood,

6 - pith.

Under what number is (numbers are) the zone due to which the formation of conductive tissues occurs and the trunk grows in width?

Variant 1:

A) 2, 4;

B) 3;

C) 4, 5;

D) 6;

Variant 2:

A) 1;

B) 2;

C) 3;

D) 1, 2;

Variant 3:

- A) 1;
- B) 2, 4;
- C) 3;
- D) 5, 6;

Task ID 2 – 1 point

Common part of the question for all variants:

Look at the transverse section of one of the plant organs.

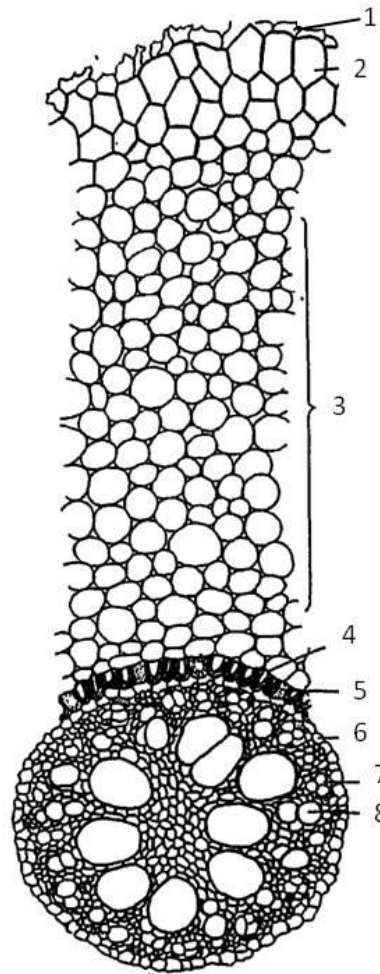

Identify an organ based on its anatomical structure:

Variant 1:

- A) Root of a monocotyledonous plant;
- B) Root of a dicotyledonous plant without secondary growth;
- C) Stem of a monocotyledonous herbaceous plant;
- D) Three-year-old branch of a woody plant living in seasonal climate;

Variant 2:

- A) Root of a dicotyledonous plant with secondary growth;
- B) Stem of a dicotyledonous herbaceous plant;
- C) Root of a monocotyledonous plant;
- D) Petiole of a monocotyledonous plant;

Variant 3:

- A) Root of a dicotyledonous plant without secondary growth;
- B) Stem of a dicotyledonous herbaceous plant;
- C) Petiole of a dicotyledonous plant;
- D) Root of a monocotyledonous plant;

Task ID 3 – 2 points

Common part of the question for all variants:

Look at the transverse section of a corn (*Zea mays*) stem in the figure 1 and schemes of different types of vascular bundles in the figure 2.

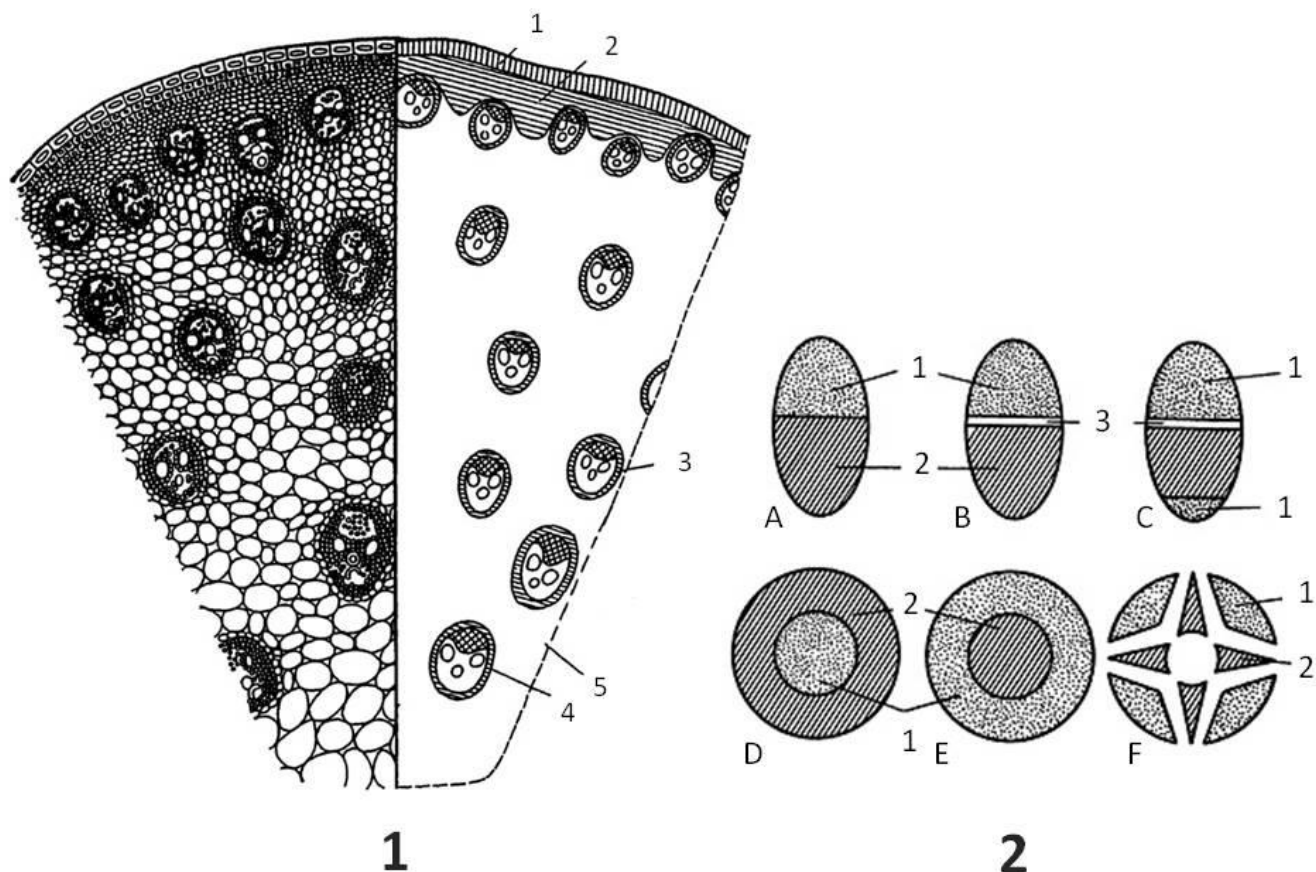

Legend.

Figure 1. The transverse section of a corn (*Zea mays*) stem:

- 1 – epidermis;
- 2 – mechanical tissue;
- 3 – vascular bundle;
- 4 – sclerenchyma surrounding of vascular bundle;
- 5 – parenchyma.

Figure 2. Types of vascular bundles:

- A – closed collateral;
- B – open collateral;
- C – open bicollateral;
- D – concentric amphivasal;
- E – concentric ampicribal;
- F – radial;
- 1 – phloem;
- 2 – xylem;
- 3 – cambium.

Choose the statement that is true for the corn stem:

Variant 1:

- A) The stem can grow in width for a long time;
- B) Vascular bundles are closed collateral;
- C) Vascular bundles are radial;
- D) Vascular bundles are open collateral;

Variant 2:

- A) Vascular bundles are concentric amphivasal;
- B) Vascular bundles are arranged in one ring;
- C) Vascular bundles are closed collateral;
- D) Cambium is actively functioning;

Variant 3:

- A) Vascular bundles are closed collateral;
- B) Vascular bundles are concentric amphicribal;
- C) Vascular bundles are open collateral;
- D) Cambium is actively functioning;

Task ID 4 – 1 point

Common part of the question for all variants:

Germander speedwell (*Veronica chamaedrys* L.) and broadleaf plantain (*Plantago major* L.) historically belonged to different taxa. However, they were merged into the Family Plantaginaceae according to phylogenetic data. The figure below illustrates the external structure of these plants.



Plantago major L.

Veronica chamaedrys L.

Figure captions: 1 – flowering shoot; 2 – flower; 3 – a longitudinal section of a flower; 4 – fruit. Which of the signs of the external structure is the most indicative of their relationship?

Variant 1:

- A) Leaf structure;
- B) Fruit type;
- C) Perianth structure;
- D) Androecium structure;

Variant 2:

- A) Root system structure;
- B) Fruit type;
- C) Type of plant stem growth habits;
- D) Perianth structure;

Variant 3:

- A) Life-form;
- B) Perianth form;
- C) Fruit type;
- D) Androecium structure;

Task ID 5 – 1 point

Common part of the question for all variants:

Okroshka is a popular Russian summer dish. This is a cold soup based on kvass (a traditional fermented beverage commonly made from rye bread) with the addition of vegetables and herbs. Okroshka may include potatoes (*Solanum tuberosum* L., fig. 1), cucumber (*Cucumis sativus* L., fig. 2), green peas (*Pisum sativum* L., fig. 3), dill (*Anethum graveolens* L., fig. 4), radishes (*Raphanus sativus* var. *Radicula* Pers., fig. 5), horseradish (*Armoracia rusticana* G. Gaertn., B. Mey. & Scherb., fig. 6), mustard (*Sinapis alba* L., fig. 7) and onion (*Allium cepa* L., fig. 8). The photographs show the listed plants.



How many species of the plants mentioned in the recipe of okroshka have specialized shoots?

Variant 1:

- A) One;
- B) Two;
- C) Three;
- D) Four;

Variant 2:

- A) Four;
- B) Five;
- C) Six;
- D) Seven;

Variant 3:

- A) Two;

- B) Four;
- C) Six;
- D) Eight;

Task ID 6 – 2 points

Common part of the question for all variants:

Peter completed a geobotanical description of two forest areas (site 1 - control area, site 2 - deforested area) of his course research. He determined the spectra of life-forms of plants according to the Raunkiær plant life form system (1905) and presented the results in diagrams, using the absolute number of detected species.

Then he compared his results with the spectra in % of the total number of studied species, obtained by Robert Harding Whittaker (1980):

1. Tropical rainforest: phanerophytes - 96%, chamaephytes - 2%, cryptophytes - 2%;
2. Subtropical forest: phanerophytes - 66%, chamaephytes - 17%, hemicryptophytes - 2%, cryptophytes - 5%, terophytes - 10%;
3. Forest of temperate climatic zone: phanerophytes - 10%, chamaephytes - 17%, hemicryptophytes - 54%, cryptophytes - 12%, theophytes - 7%;
4. Desert: chamaephytes - 4%, hemicryptophytes - 17%, geophytes - 6%, theophytes - 73%;
5. Tundra: phanerophytes - 1%, chamaephytes - 22%, hemicryptophytes - 60%, cryptophytes - 15%, theophytes - 2%.

The figure below shows the structure of plants belonging to different life forms: Phanerophytes, Chamaephytes, Hemicryptophytes, Criptophytes, Therophytes; the spectra of life forms for the main terrestrial ecosystems, sites 1 and 2. The numbers indicate the number of plant species related to this life form.

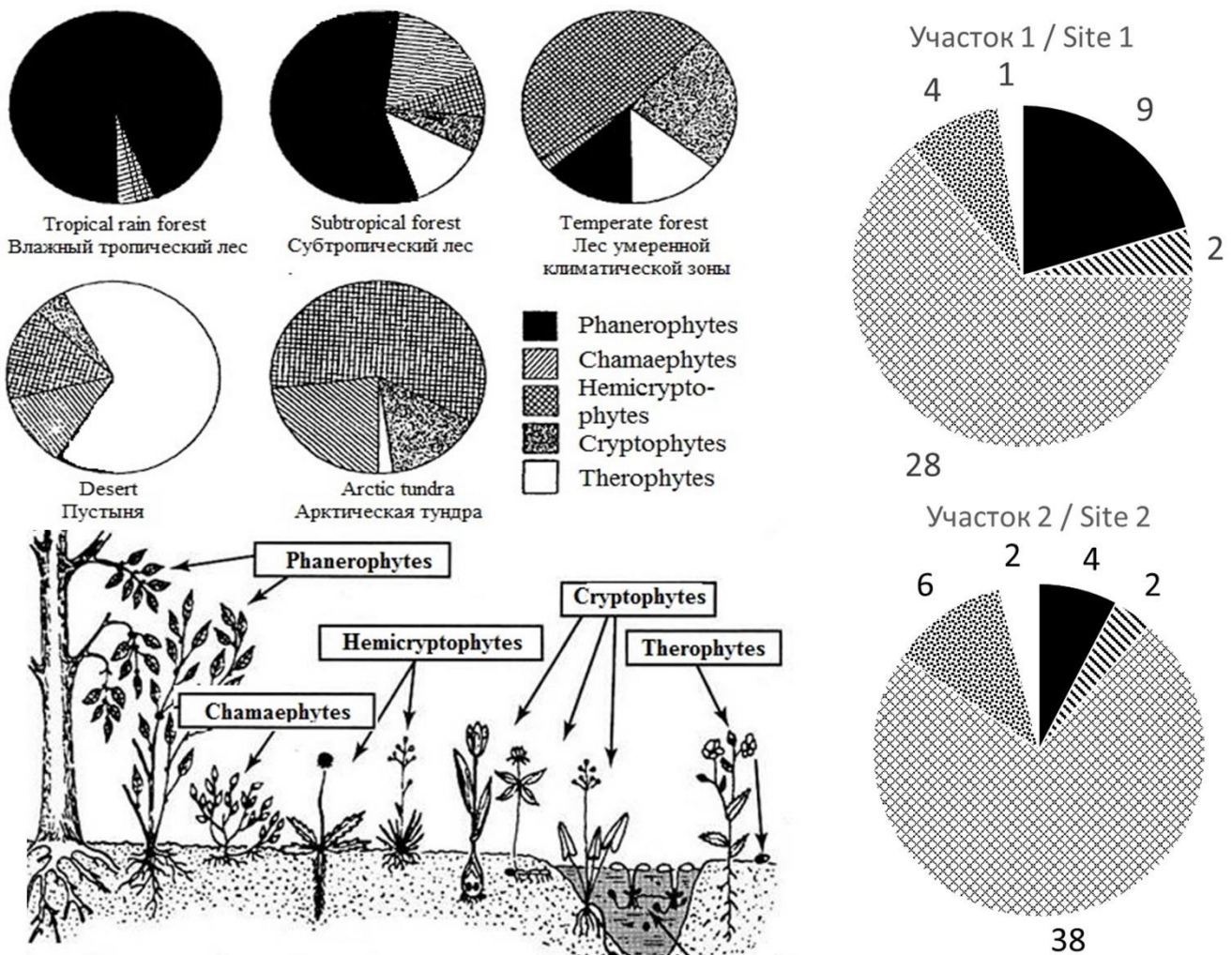

Help Peter analyze the data and make a conclusion about the environment of the researched sites. Choose the right statement:

Variant 1:

- A) Site 1 belongs to a climatic climax community for the Central Russian taiga zone;
- B) Site 2 has been subject to significant anthropogenic pressure for several decades because of the high proportion of annual plants in the spectrum;
- C) Site 2 has a higher biological productivity (biomass formation rate), than site1;
- D) The results of the study confirm that clear-cuts reduce the number of species in the phytocenosis;

Variant 2:

- A) Site 2 has fewer plant species than site 1;
- B) Human intervention is required to recovery site 2;
- C) Site 1 belongs to a climatic climax community for the Central Russian taiga zone;
- D) The yield of perennial medicinal herbs and berries in site 1 is higher than in site 2;

Variant 3:

- A) Sites 1 and 2 have the same number of plant species;
- B) Site 1 belongs to a climatic climax community for the Central Russian taiga zone;
- C) The increase in the share of perennial grasses in site 2 is explained by a decrease in interspecific competition in the herb layer;
- D) The nitrogen entering the soil during the decomposition of dead plant parts in site 1 is higher than in site 2;

Task ID 7 – 1 point

Common part of the question for all variants:

Here you are presented with images of various representatives of phylum *Mollusca*.



Which one of the listed morphological structures appears in every one of these animals?

Variant 1:

- A) Radula;
- B) Gladius;
- C) Mantle;
- D) Branchial hearts;

Variant 2:

- A) Byssus gland;
- B) Mantle;
- C) Shell;
- D) Syphon;

Variant 3:

- A) Radula;
- B) Gills;
- C) Syphon;
- D) Mantle;

Task ID 8 – 1 point

Common part of the question for all variants:

Which of the following arthropods has mandibles, maxillae and maxillipeds among its mouthparts?

Variant 1:

- A) European mantis (*Mantis religiosa*);
- B) Domestic house spider (*Tegenaria domestica*);
- C) European lobster (*Homarus gammarus*);
- D) Acorn barnacle (*Balanus balanus*);

Variant 2:

- A) Emperor scorpion (*Pandinus imperator*);
- B) Western honey bee (*Apis mellifera*);
- C) European lobster (*Homarus gammarus*);
- D) Water flea (*Daphnia pulex*);

Variant 3:

- A) European lobster (*Homarus gammarus*);
- B) European mantis (*Mantis religiosa*);
- C) European house dust mite (*Dermatophagoides pteronyssinus*);
- D) Water flea (*Daphnia pulex*);

Task ID 9 – 2 points

Common part of the question for all variants:

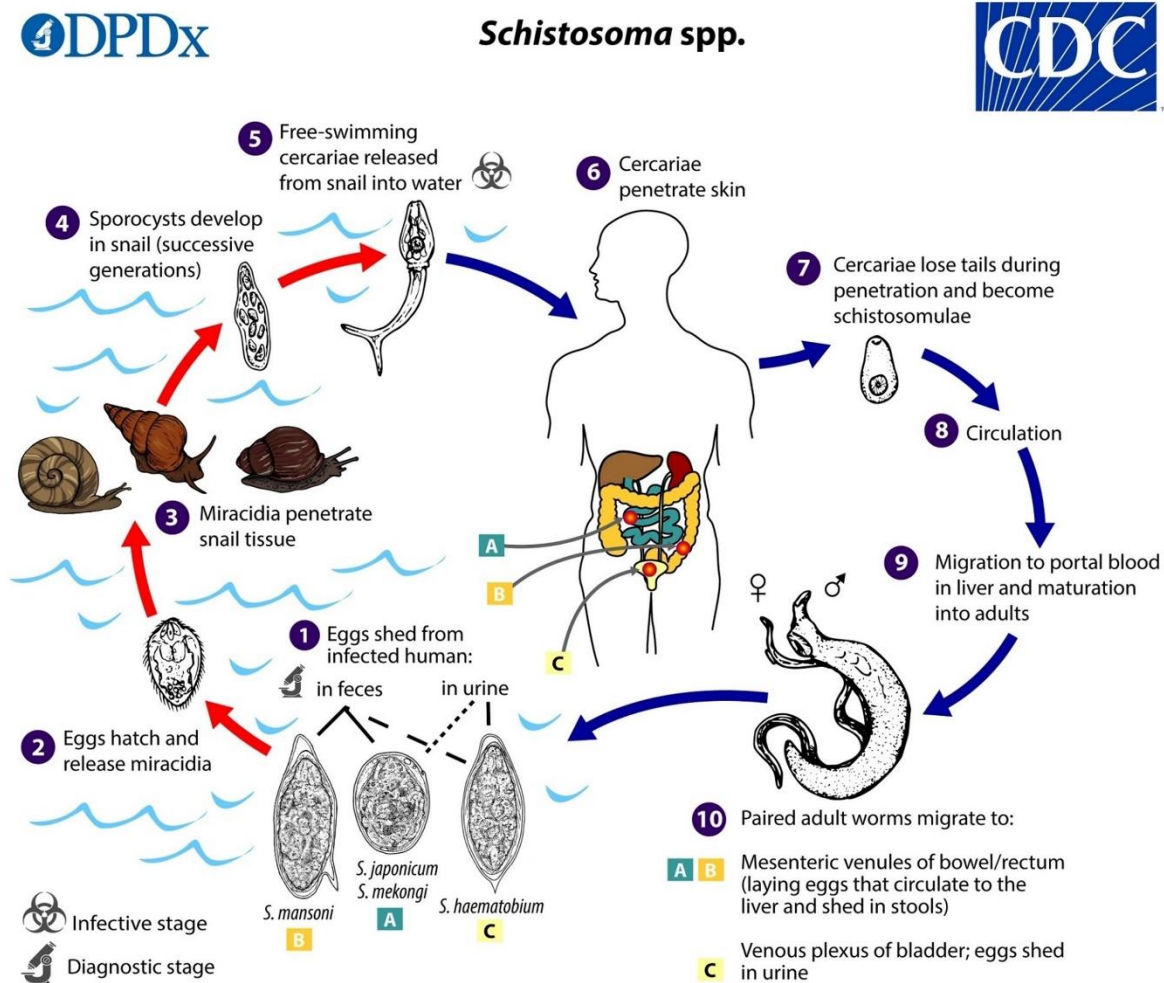
You are presented with a life cycle of a parasitic digenean trematode of the genus *Schistosoma*.**Which one of its life stages reproduces asexually?***Variant 1:*

- A) 10 - Adult worms in the veins of a definitive mammalian host;
- B) 7 - Young schistosomulae that recently invaded a definitive host;
- C) 4 - Sporocyst in an intermediate host – a gastropod mollusc;
- D) 2 - Swimming miracidia larvae in search of an intermediate host;

Variant 2:

- A) 1 - Developing eggs spread by the definitive host;
- B) 4 - Sporocyst in an intermediate host – a gastropod mollusc;
- C) 5 - Swimming cercaria stage spread by the intermediate host;
- D) 10 - Adult males in the veins of a definitive mammalian host;

Variant 3:

- A) 1 - Developing eggs spread by the definitive host;
- B) 2 - Swimming miracidia larvae in search of an intermediate host;
- C) 4 - Sporocyst in an intermediate host – a gastropod mollusc;
- D) 10 - Adult females in the veins of a definitive mammalian host;

Task ID 10 – 1 point

Common part of the question for all variants:

Below is a photograph of a typical animal of order Bats (Chiroptera).



What bones form the wing of a bat?

Variant 1:

- A) Humerus;
- B) Humerus, forearm bones and manus;
- C) Radius only;
- D) Finger bones only;

Variant 2:

- A) Femur;
- B) Ulna only;
- C) Humerus, forearm bones and manus;
- D) Tibia;

Variant 3:

- A) Humerus, forearm bones and manus;
- B) Humerus;
- C) Ulna only;
- D) There are no bones in the wing membrane - these are elastic cartilage;

Task ID 11 – 1 point

Common part of the question for all variants:

Females of 8 species of moles, including the European mole (*Talpa europaea*), are intersexual. In recent studies (Real, 2020) scientists showed that 2 mutations are responsible for that.



What is intersexuality?

Variant 1:

- A) Female moles have ovotestes instead of ovaries. Ovotestes are gonads that produce ovaries and male hormones (androgens) at the same time. As a consequence of increased androgen synthesis, female moles develop prominent muscles and aggressive behavior as an adaptation to a subterranean lifestyle;
- B) Female moles gonads produce both female and male gametes. When the number of males in population decreases, females produce sperm;
- C) This is a type of relationship between individuals, when females can have 2 or more sexual partners during the breeding season;
- D) This is when the females are larger than the males. In mammals, more often, males are much larger than females. But in moles, the situation is the opposite;

Variant 2:

- A) This is a type of reproduction when the egg does not need to be fertilized with sperm. This is an adaptation to constant darkness underground, since it is difficult to find a sexual partner in such conditions;
- B) That means that there is no difference between female and male moles;
- C) Female moles have ovotestes instead of ovaries. Ovotestes are gonads that produce ovaries and male hormones (androgens) at the same time. As a consequence of increased androgen synthesis, female moles develop prominent muscles and aggressive behavior as an adaptation to a subterranean lifestyle;
- D) This is a type of breeding where males mate with a large number of females.

Variant 3:

- A) Female moles have ovotestes instead of ovaries. Ovotestes are gonads that produce ovaries and male hormones (androgens) at the same time. As a consequence of increased androgen synthesis, female moles develop prominent muscles and aggressive behavior as an adaptation to a subterranean lifestyle;

- B) Female moles gonads produce both female and male gametes. When the number of males in population decreases, females produce sperm;
- C) That means that there is no difference between female and male moles;
- D) Female moles may refuse to breed and not participate in the breeding season;

Task ID 12 - 2 points

Common part of the question for all variants:

What is the number on the map below for the distribution area of the polar bear (*Ursus maritimus*)?

Variant 1:

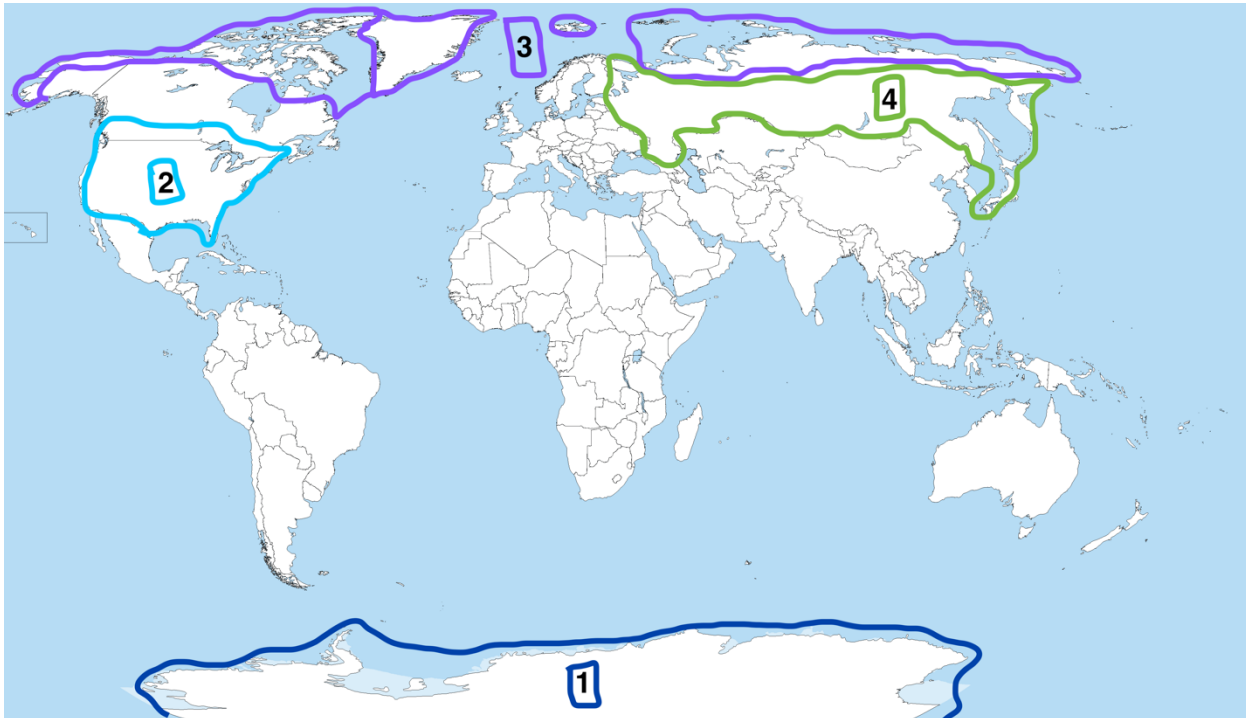

- A) 3;
- B) 4;
- C) 2;
- D) 1.

Variant 2:

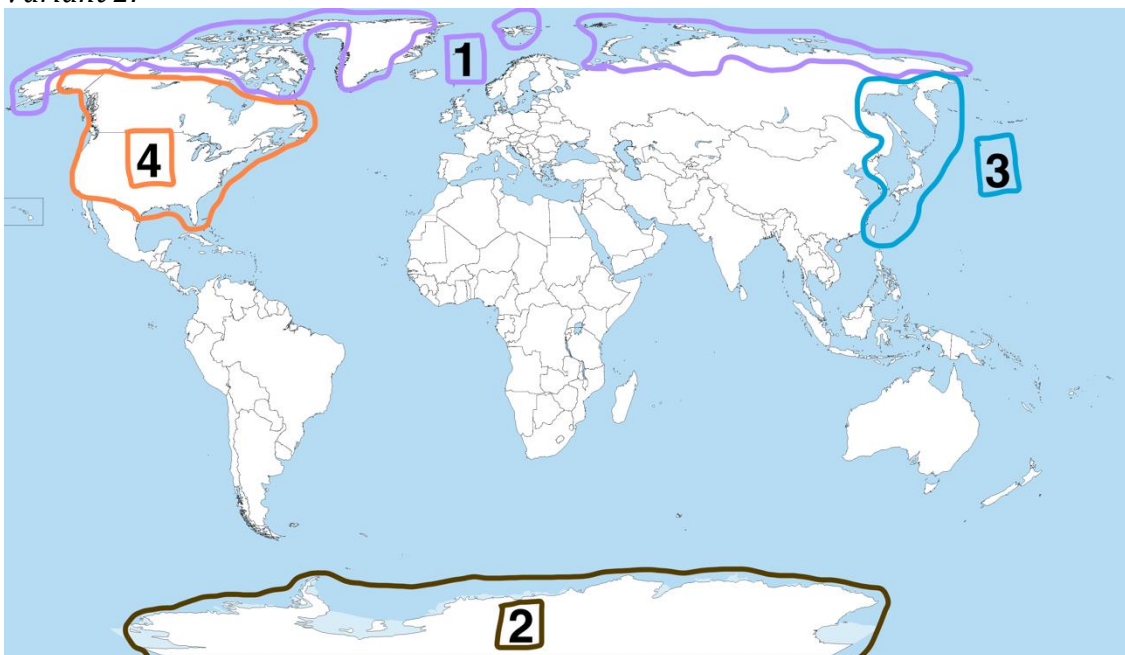

- A) 1;

- B) 2;
- C) 3;
- D) 4.

Variant 3:

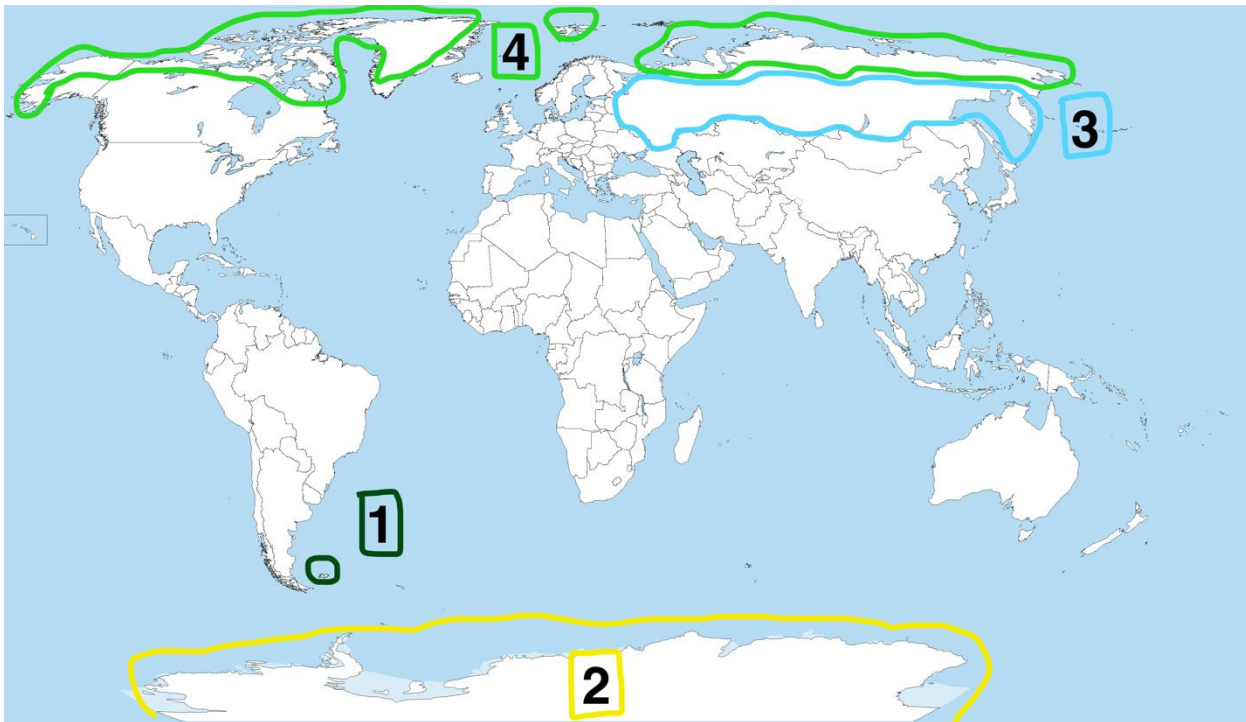

- A) 4;
- B) 1;
- C) 2;
- D) 3.

Task ID 14 - 1 point

Common part of the question for all variants:

Syndrome of congenital adrenal hyperplasia is a group of hereditary diseases, one of the possible causes of which is a mutation in the gene encoding the enzyme for the synthesis of cortisol, which leads to a decrease in the concentration of cortisol in the blood of the fetus. The diagram shows the scheme of regulation of the development of the reproductive system by the adrenal glands in the embryonic period.

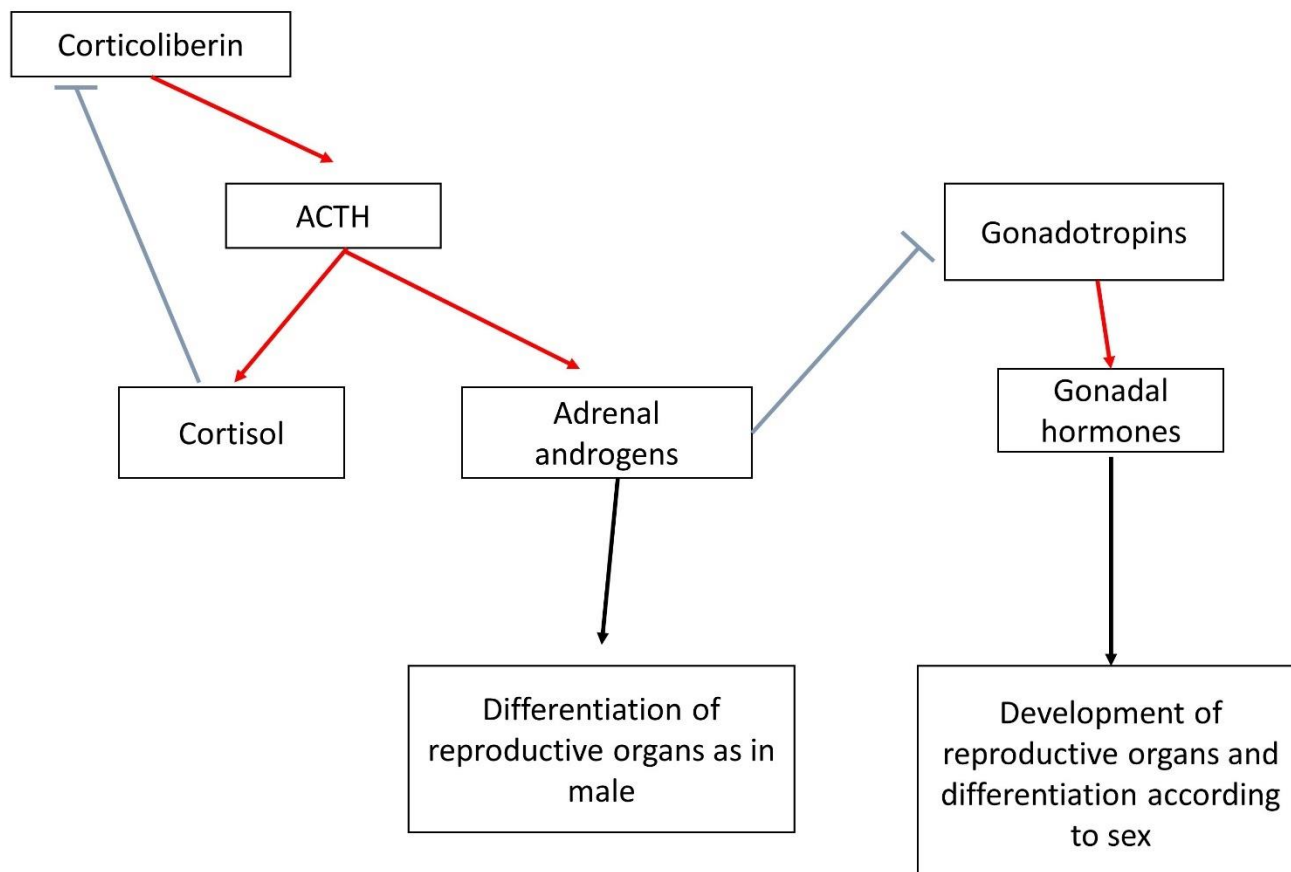

Red arrows indicate activating influences, blue ones - inhibiting ones, ACTH - adrenocorticotrophic hormone, LH - luteinizing hormone, FSH - follicle-stimulating hormone. What are the consequences of this?

Variant 1:

- A) To the differentiation of secondary genital organs in girls according to the male type;
- B) To a decrease in ACTH production;
- C) To excess secretion of LH;
- D) To the development of reproductive organs in boys according to the female type;

Variant 2:

- A) To a reduction of adrenal androgen production;
- B) To an excess secretion of FSH;
- C) To the differentiation of secondary genital organs in girls according to the male type;
- D) To an increase in the size of the testes in boys;

Variant 3:

- A) To an enhancement the negative feedback mechanism of ACTH production;

- B) To the differentiation of secondary genital organs in girls according to the male type;
- C) To reduce the size of the adrenal glands;
- D) To an increase in the size of the ovaries in girls;

Task ID 15 – 2 points

Common part of the question for all variants:

Alcohol entering the human body stimulates the dopaminergic and serotonergic systems of the brain, provoking its further consumption and stimulating the development of addiction. At the same time, in the liver, by the enzyme alcohol dehydrogenase (ADH), it turns into a more toxic acetaldehyde, which causes painful symptoms of intoxication. Acetaldehyde, in turn, under the influence of the enzyme aldehyde dehydrogenase (ALDH) is converted into acetic acid, which is easily excreted from the body. In humans, there are several variants of these enzymes of different activity, which creates variability in the population in the degree of intoxication and the strength of the hangover, which in turn determines the tendency to form dependence on alcohol. Check the correct statement:

Variant 1:

- A) Higher ALDH activity compared to ADH contributes to severe hangover;
- B) One of the methods to combat alcoholism is to inhibit ADH;
- C) Pharmacological blockade of ALDH can make a person averse to alcohol;
- D) Activating mutations in the gene responsible for the reuptake of serotonin from the synaptic cleft increase the risk of alcoholism;

Variant 2:

- A) Pharmacological blockade of ALDH can make a person averse to alcohol;
- B) Higher ALDH activity compared to ADH contributes to severe hangover;
- C) One of the methods to combat alcoholism is to inhibit ALDH;
- D) Activating mutations of dopamine receptors, as a result of which alcohol saturation occurs faster, increase the risk of developing alcoholism;

Variant 3:

- A) Activating mutations in the gene of monoamine oxidase metabolizing bioamines increase the risk of alcoholism;
- B) Higher ADH activity compared to ALDH contributes to the onset of alcoholism;
- C) One of the methods to combat alcoholism is to inhibit ALDH;
- D) Pharmacological blockade of ALDH can make a person averse to alcohol;

Task ID 16 – 1 point

Common part of the question for all variants:

The figure below is an electronic micrograph of an endocrine cell.

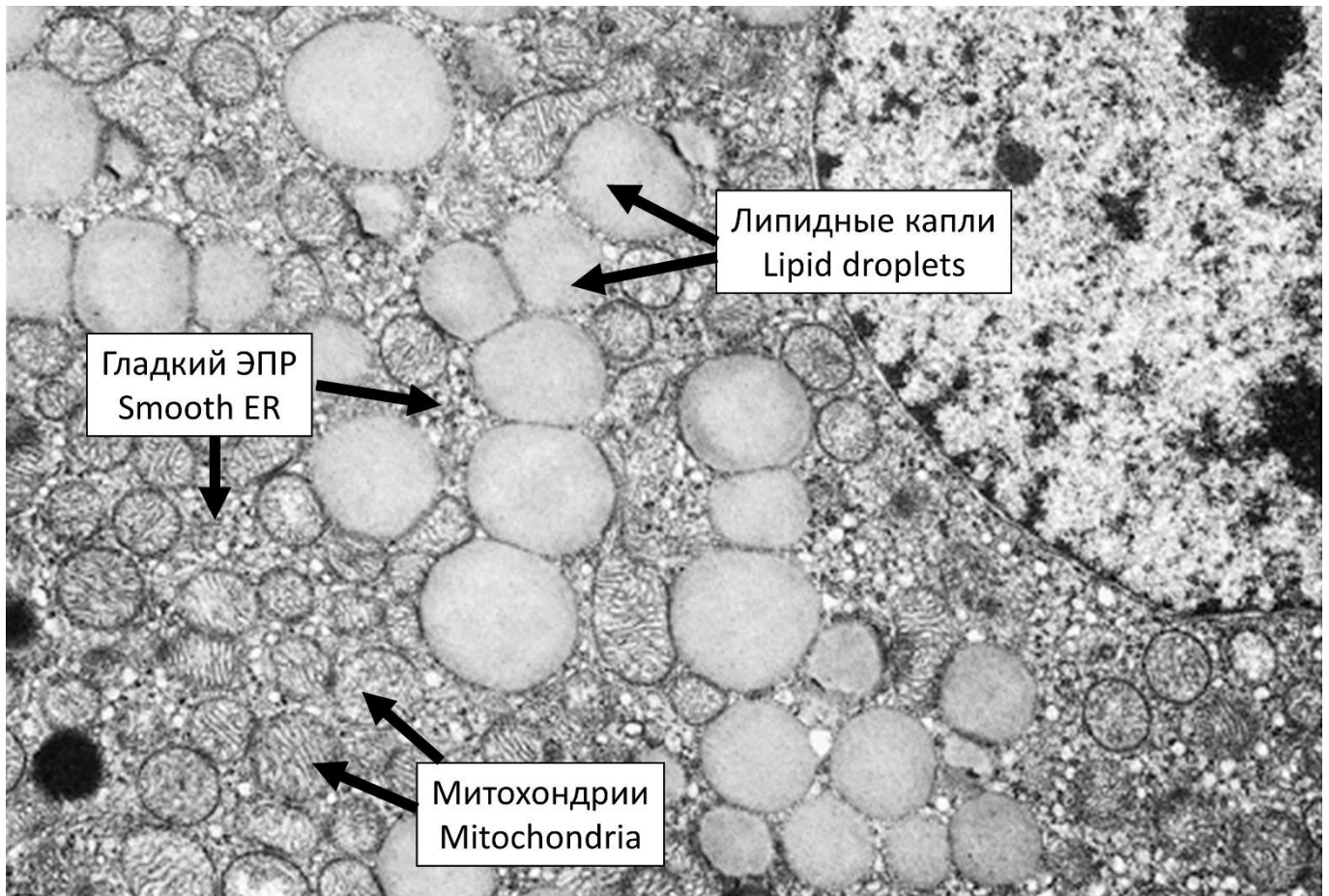

Which of the following hormones is most likely to be produced by this cell?

Variant 1:

- A) Aldosterone;
- B) Thyroxine;
- C) Oxytocin;
- D) Prolactin;

Variant 2:

- A) Adrenaline;
- B) Aldosterone;
- C) Insulin;
- D) Growth hormone;

Variant 3:

- A) Prolactin;
- B) Adrenaline;
- C) Glucagon;
- D) Aldosterone;

Task ID 17 – 1 point

Common part of the question for all variants:

Medial plantar nerve is a mixed nerve, i.e. it contains both sensory and motor fibers. A researcher stimulated the nerve and recorded electrical response of intrinsic plantar muscles using a needle electrode. After stimulus application, two peaks were registered on electromyogram (EMG – a graphical recording of muscle electrical activity): wave 1 appeared almost immediately after nerve stimulation, and wave 2 appeared after some latency period. In the second part of the study, the sciatic nerve was transected (medial plantar nerve can be viewed as one of terminal branches of the sciatic nerve) and the same experiment was repeated (medial plantar nerve stimulation with simultaneous EMG recording). The figure below illustrates overall design of the study and EMG recordings before and after sciatic nerve transection.

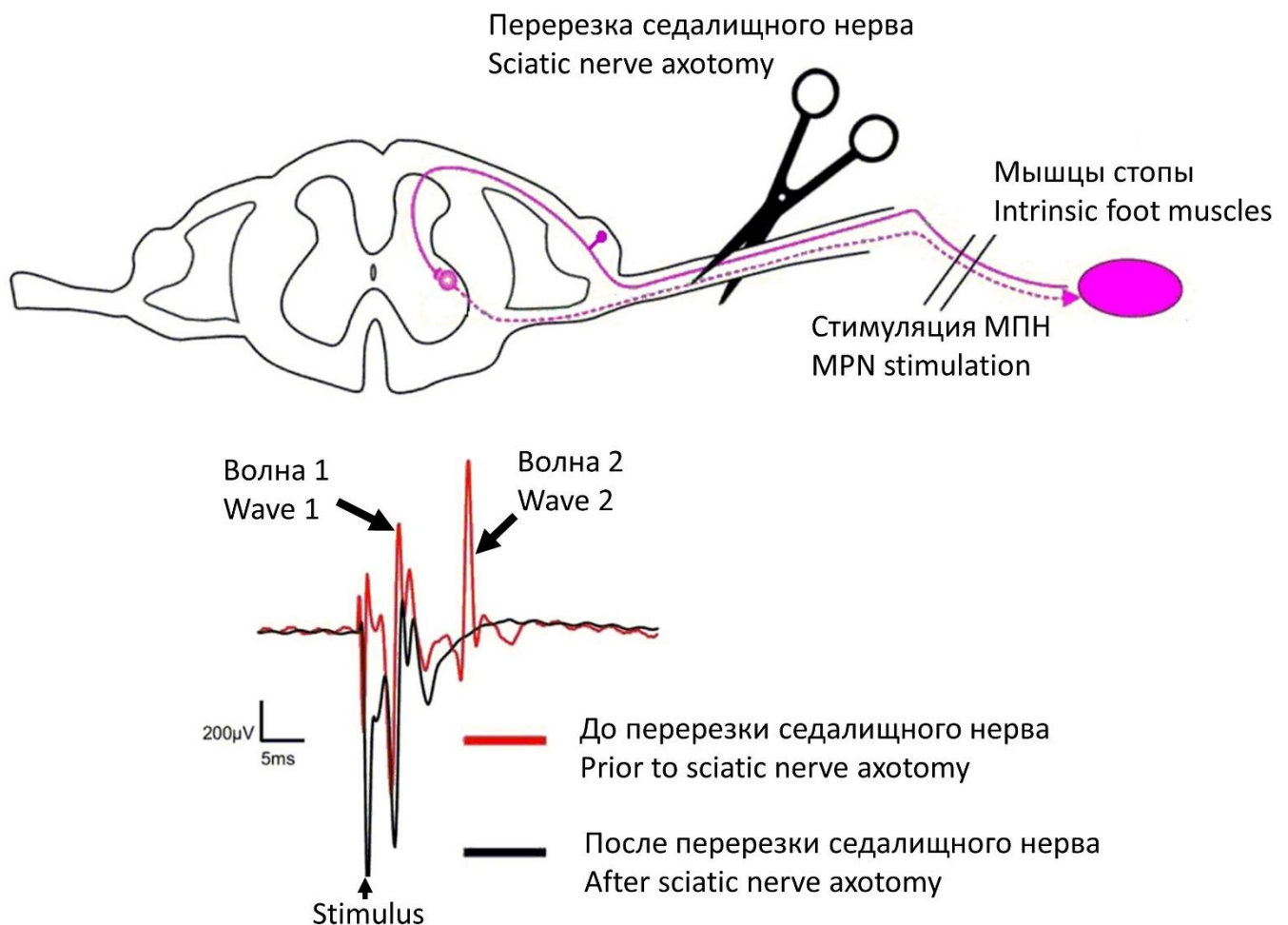

Below is the list of some other possible interventions. Which of them will not affect intrinsic foot muscle EMG recordings upon medial plantar nerve stimulation (compared to intact animal, i.e. there will still be the same two waves on EMG)?

Variant 1:

- A) Selective transection of motor fibers in sciatic nerve;
- B) Transection of ventral roots of the corresponding spinal cord segment;
- C) Selective transection of sensory fibers in medial plantar nerve distal to stimulation point;
- D) All of the above;

Variant 2:

- A) Selective transection of sensory fibers in medial plantar nerve distal to stimulation point;
- B) Selective transection of sensory fibers in sciatic nerve;

- C) Transection of dorsal roots of the corresponding spinal cord segment;
- D) None of the above;

Variant 3:

- A) Selective transection of sensory fibers in sciatic nerve;
- B) Transection of ventral roots of the corresponding spinal cord segment;
- C) Selective transection of sensory fibers in medial plantar nerve distal to stimulation point;
- D) All of the above;

Task ID 18 – 2 points

Common part of the question for all variants:

Bile plays a key role in fat digestion in the small intestine. The so-called primary bile acids are one of the major components of bile and are synthesized from cholesterol in liver cells (hepatocytes). Below you can find some short notes on the regulation of bile acid biosynthesis as well as illustration of this process (BA – bile acid).

The first step in bile acid synthesis is 7- α -hydroxylation of cholesterol, catalyzed by CYP7A1 enzyme. This is a rate-limiting stage of the whole pathway and is under strict control (see below).

Only 5% of secreted bile acid pool is excreted in feces, whereas the remainder 95% is reabsorbed in ileum (distal part of small intestine) and returns to the liver. Within the epithelial cells of ileal mucosa reabsorbed bile acids bind to a receptor called farnesoid X receptor (FXR). This increases expression of the protein FGF15/19 which is one of key regulators of the bile acid turnover. FGF15/19 is secreted into portal system bloodstream and thereby reaches the liver, where it binds to receptors (FGFR4) in liver cell membrane and inhibits CYP7A1 expression. As a result, bile acid synthesis is reduced.

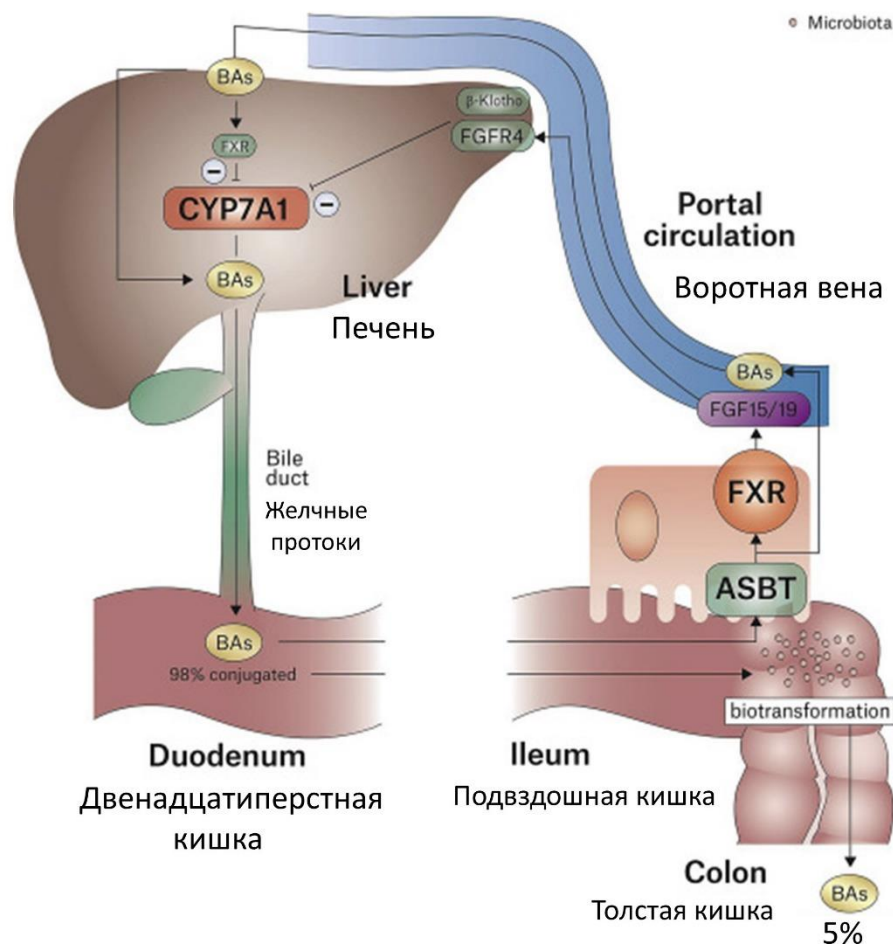

Which of the following statements are correct?

Variant 1:

- A) Surgical removal of ileum impairs dietary fat absorption, because ileum is a major site of fat digestion;
- B) If one blocks bile acid absorption using certain medications, this will lead to a decrease in FGF15/19 plasma concentration;
- C) During the day FGF15/19 secretion reaches maximum with prolonged fasting periods and is significantly reduced after meals;

D) All of the above.

Variant 2:

A) Blocking bile acid absorption using certain medications will stimulate bile acid synthesis in liver cells;

B) Surgical removal of ileum will most likely significantly increase dietary fat absorption, because there will be no negative feedback loop controlling bile acid synthesis;

C) During the day FGF15/19 secretion reaches maximum with prolonged fasting periods and is significantly reduced after meals;

D) All of the above.

Variant 3:

A) Surgical removal of ileum impairs dietary fat absorption, because ileum is a major site of fat digestion;

B) Ingestion of fat-rich meals suppresses FGF15/19 secretion;

C) Surgical removal of the ileum will stimulate bile acid synthesis in liver cells;

D) All of the above.

Task ID 19 – 1 point

Common part of the question for all variants:

The picture below shows a pathway of a glucose breakdown. Enzymes involved in glycolysis are marked in blue. Some of the enzymes are hidden.

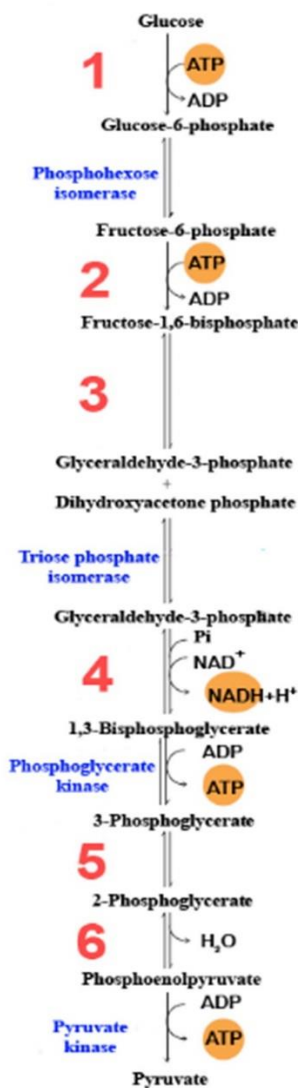

What enzymes are indicated by numbers? Choose the right combination of numbers and protein names.

Variant 1:

- A) 1 – Hexokinase, 2 – Aldolase, 3 – Phosphofructokinase-1, 4 – Glyceraldehyde 3-phosphate dehydrogenase, 5 – Enolase, 6 – Mutase;
- B) 1 – Mutase, 2 – Aldolase, 3 – Phosphofructokinase-1, 4 – Hexokinase, 5 – Enolase, 6 – Glyceraldehyde 3-phosphate dehydrogenase;
- C) 1 – Hexokinase, 2 – Phosphofructokinase-1, 3 – Aldolase, 4 – Glyceraldehyde 3-phosphate dehydrogenase, 5 – Mutase, 6 – Enolase;
- D) 1 – Aldolase, 2 – Hexokinase, 3 – Glyceraldehyde 3-phosphate dehydrogenase, 4 – Phosphofructokinase-1, 5 – Enolase, 6 – Mutase;

Variant 2:

- A) 1 – Phosphofructokinase-1, 2 – Hexokinase, 3 – Mutase, 4 – Glyceraldehyde 3-phosphate dehydrogenase, 5 – Enolase, 6 – Aldolase;

- B) 1 – Aldolase, 2 – Hexokinase 3 – Glyceraldehyde 3-phosphate dehydrogenase, 4 – Phosphofructokinase-1, 5 – Mutase, 6 – Enolase;
C) 1 – Hexokinase, 2 – Mutase, 3 – Phosphofructokinase-1, 4 – Glyceraldehyde 3-phosphate dehydrogenase, 5 – Enolase, 6 – Aldolase;
D) 1 – Hexokinase, 2 – Phosphofructokinase-1, 3 – Aldolase, 4 – Glyceraldehyde 3-phosphate dehydrogenase, 5 – Mutase, 6 – Enolase;

Variant 3:

- A) 1 – Hexokinase, 2 – Phosphofructokinase-1, 3 – Aldolase, 4 – Glyceraldehyde 3-phosphate dehydrogenase, 5 – Mutase, 6 – Enolase;
B) 1 – Mutase, 2 – Aldolase, 3 – Phosphofructokinase-1, 4 – Hexokinase, 5 – Enolase, 6 – Glyceraldehyde 3-phosphate dehydrogenase;
C) 1 – Aldolase, 2 – Hexokinase 3 – Glyceraldehyde 3-phosphate dehydrogenase, 4 – Phosphofructokinase-1, 5 – Mutase, 6 – Enolase;
D) 1 – Phosphofructokinase-1, 2 – Hexokinase, 3 – Aldolase, 4 – Glyceraldehyde 3-phosphate dehydrogenase, 5 – Enolase, 6 – Mutase;

Task ID 22 – 1 point

Common part of the question for all variants:

The organization of chromosomes inside the cell nucleus is closely related to regulation of gene expression. Eukaryotic chromosomes are arranged in the form of isolated from each other compact regions — topologically associated domains (TADs). These domains are characterized by preferential chromatin interactions within them, and spatial separation of loci located in different domains. Thus there is a coordinated influence of genome regions on each other inside the TAD.

There are special sequences in the genome that control gene expression — enhancers and insulators. The regulation mechanism can be described by the following rules:

- An inactive gene makes the neighboring genes inactive;
- The enhancer (E) increases the activity of the neighboring genes and turns on inactive ones;
- The enhancer remains active when its sequence is inverted;
- An inactive gene and enhancers influence the neighboring genes within one TAD;
- The insulator (I) forms the border between the TADs;

Some times only a small chromosomal rearrangement leads to incorrect packing of chromosomes with dire consequences: the normal regulation of gene expression disrupts that results in cancer.

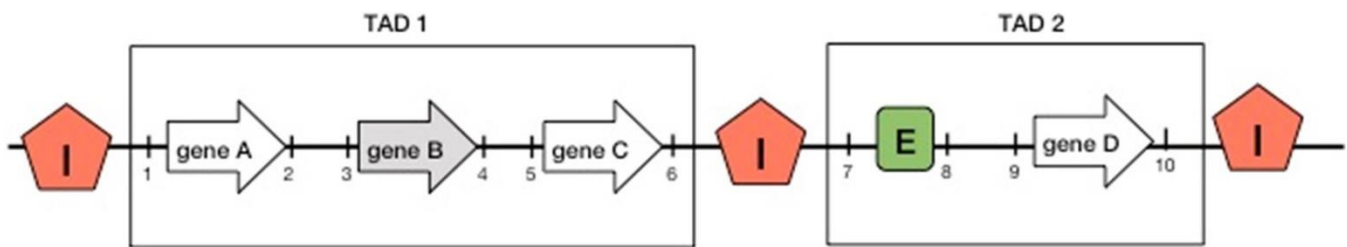

Consider the diagram above and choose the correct statement, provided that the gene B is normally inactive (marked in gray):

Variant 1:

- Genes A, C and D are normally active;
- When the region «6-8» is inverted, genes A, B, C are active while gene D is inactive;
- When the region «4-8» is deleted, gene D is active;
- When the region «6-7» is translocated to the site of the genome designated by the number «5», the C gene is inactive;

Variant 2:

- When the region «6-8» is deleted, genes A, B, C are inactive while gene D is active;
- When the region «6-7» is translocated to the site of the genome designated by the number «3», genes A and C are inactive;
- When the region «6-8» is inverted, genes A, B, C are active while gene D is inactive;
- When the region «6-8» is deleted, the gene D is active;

Variant 3:

- When the region «6-7» is translocated to the site of the genome designated by the number «5», the C gene is inactive;
- Genes A, C and D are normally active;
- When the region «6-8» is deleted, genes A, B, C are inactive while gene D is active;
- When the region «6-8» is inverted, genes A, B, C are active while gene D is inactive;

Task ID 25 – 1 point

Common part of the question for all variants:

The bL33 protein is one of the proteins of the large subunit of the bacterial ribosome. A ribosome protein homologous to bL33 can be found in a eukaryotic cell. In which compartment of the eukaryotic cell the homologue bL33 accumulates?

Variant 1:

- A) Nucleus;
- B) Lysosome;
- C) Mitochondrial matrix;
- D) Cytoplasm;

Variant 2:

- A) Vacuole.
- B) Golgi apparatus;
- C) Cytoplasm;
- D) Mitochondrial matrix;

Variant 3:

- A) ER;
- B) Mitochondrial matrix;
- C) Plasma membrane;
- D) Vacuole.

Task ID 28 – 1 point

Common part of the question for all variants:

The gene for eye color has two alleles: A for brown eyes and a for blue eyes. Two heterozygous people got married and gave a life for 3 children. What is a probability to have at least one brown-eyed child among this three (values are rounded off)?

Variant 1:

- A) 0,156;
- B) 0,875;
- C) 0,984;
- D) 0,5;

Variant 2:

- A) 0,125;
- B) 0,578;
- C) 0,984;
- D) 0,25;

Variant 3:

- A) 0,984;
- B) 0,422;
- C) 0,75;
- D) 0,125;

Task ID 31 – 1 point

Common part of the question for all variants:

Which of the following statements does not apply to the struggle for existence?

Variant 1:

- A) Elimination of some individuals of the species from reproduction due to lack of breeding grounds;
- B) Selective death of some individuals in cold winter;
- C) The death of the entire population as a result of a volcanic eruption;
- D) The death of a part of the population as a result of competition for food;

Variant 2:

- A) The death of some individuals unable to find food;
- B) Elimination of individual males from breeding due to lack of females;
- C) Selective death of some individuals from a predator;
- D) The death of the entire population as a result of a volcanic eruption;

Variant 3:

- A) The death of the entire population as a result of a volcanic eruption;
- B) Suppression of individual plants as a result of shading by other species;
- C) Elimination of individual males from reproduction due to high competition for the female;
- D) Selective death of some individuals in drought;

Part B: Multiple Choice Questions (True / False)

In all the tasks of this part, there is a condition at the beginning, and then six answer options (under the letters from A to F). Participants need to determine whether each of the answer options is correct (fits the problem statement) or incorrect (does not fit the job statement). Each task can have from 1 to 6 correct answers.

Grading system:

For each correctly marked statement, you can get 0.5 points

For each incorrectly marked statement - 0 points

Correct answers are underlined

Task ID 34 – 3 points

Common part of the question for all variants:

Look at two cross sections of leaves.

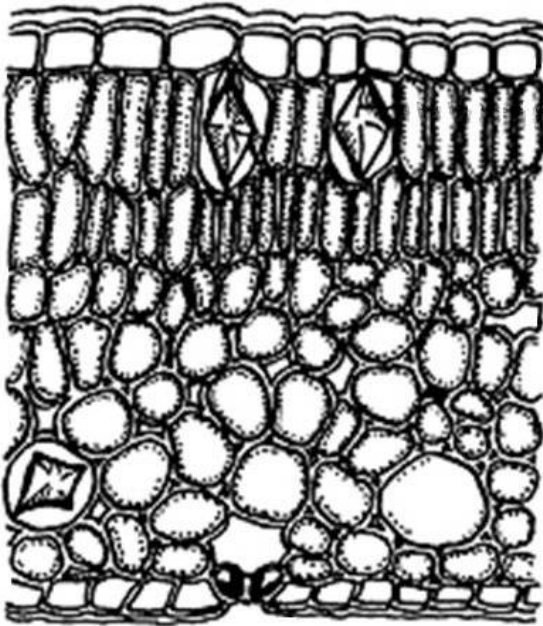

1

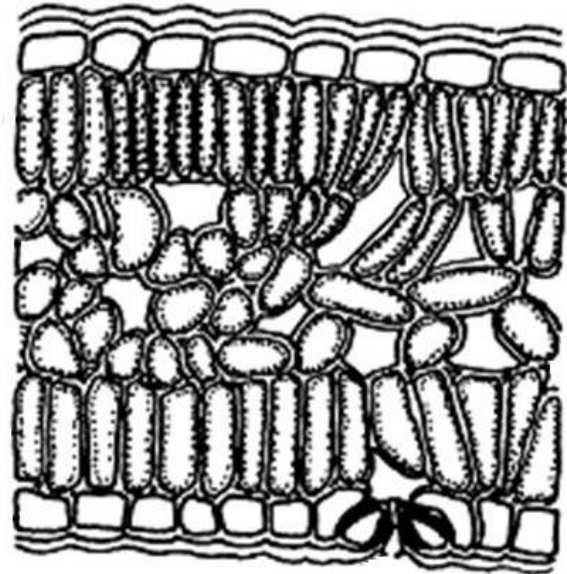

2

For each of the following statements, indicate whether it is true or false:

Variant 1:

- A) Both leaves belong to aquatic plants and are completely submerged in water;
- B) The leaf 2 has a palisade mesophyll on both the upper and lower sides;
- C) The leaf 2 belongs to a shade-loving plant;
- D) The leaf 1 has crystal-bearing cells;
- E) The leaf 2 has crystal-bearing cells;
- F) The leaf 1 has stomata both on stomata are located both on the lower and upper sides;

Variant 2:

- A) Both leaves belong to aquatic plants and are completely submerged in water;
- B) The leaf 1 has a palisade mesophyll only on the upper side;
- C) The leaf 2 has a palisade mesophyll only on the lower side;
- D) The leaf 2 belongs to a shade-loving plant;
- E) The leaf 2 has crystal-bearing cells;
- F) The leaf 1 has stomata both on stomata are located both on the lower and upper sides;

Variant 3:

- A) The leaf 1 has a palisade mesophyll only on the upper side;
- B) The leaf 2 has a palisade mesophyll on both the upper and lower sides;
- C) The leaf 2 has no spongy mesophyll;
- D) The leaf 1 floats on the surface of the water;
- E) The leaf 2 does not have crystal-bearing cells;
- F) The leaf 1 has stomata only on the lower side;

Task ID 35 – 3 points

The common part of the question for all variants:

Look at the transverse section of the root.

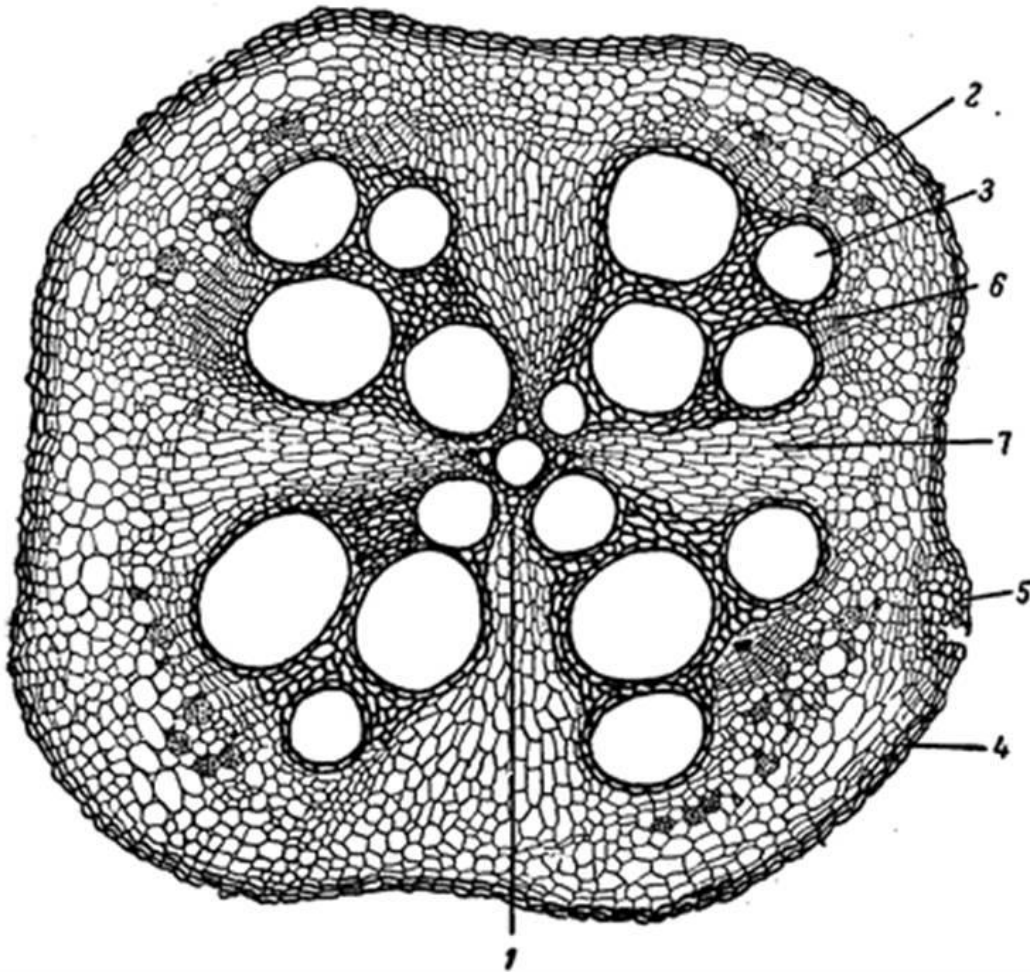

For each of the following statements, indicate whether it is true or false:

Variant 1:

- A) This is the root of a monocotyledonous plant;
- B) This root hasn't got a secondary growth;
- C) This root has got a secondary growth
- D) The root is covered by periderm;
- E) Secondary xylem is marked with the number 3;
- F) The number of rays of the primary xylem is 5;

Variant 2:

- A) This is the root of a dicotyledonous plant;
- B) This root hasn't got a secondary growth;
- C) The root is covered by rhizoderm;
- D) Primary xylem is marked with the number 1;
- E) Secondary xylem is marked with the number 2;
- F) The number of rays of the primary xylem is 4;

Variant 3:

- A) This is the root of a dicotyledonous plant;
- B) This root has got a secondary growth
- C) The root is covered by rhizoderm;

- D) Primary xylem is marked with the number 3;
- E) Secondary xylem is marked with the number 2;
- F) The number of rays of the primary xylem is 5;

Task ID 36 – 3 points

The common part of the question for all variants:

Masha lives in the Moscow region. She is fond of growing garden flowers. One day while walking, she discovered an unknown plant X with large, bright flowers. She decided to grow it in a flowerbed with asters. A year later, the new plant grew greatly and began to oppress its "neighbors". Masha decided to limit its growth, dug up one of the specimens and carefully examined its underground structures. The photo below shows the appearance of these structures. Use your knowledge of plant morphology and help Masha determine the right strategy for dealing with the aggressor.



Determine which of the statements are true or false:

Variant 1:

- A) Plant X has specialized lateral tuberous roots;
- B) Plant X has specialized storage taproot root;
- C) Plant X reproduces mainly by seeds;
- D) To completely remove plant X from the flowerbed, it is necessary to cut off the fruits with seeds in a timely manner, not allowing them to be sown;
- E) To completely remove plant X from the flowerbed, it is necessary deeply dig up flowerbed with mechanical removal of tubers;
- F) To completely remove a plant from a flowerbed without digging, it is possible to use herbicides;

Variant 2:

- A) Plant X has specialized lateral tuberous roots;

- B) Plant X has specialized stolon stems;
- C) Plant X has specialized tuberous stems;
- D) Plant X reproduces mainly vegetatively;
- E) To completely remove plant X from the flowerbed, it is necessary deeply dig up flowerbed with mechanical removal of tubers;
- F) To completely remove a plant from a flowerbed without digging, it is possible to use herbicides;

Variant 3:

- A) Plant X has specialized stolon stems;
- B) Plant X has specialized rhizome stems;
- C) Plant X has specialized tuberous stems;
- D) To completely remove plants X from the flowerbed, it is enough to cut off the aerial part of the plant;
- E) To completely remove a plant from a flowerbed without digging, it is possible to use herbicides;
- F) To completely remove the plant from the flowerbed without digging, it is possible to use a close light-tight material to cover the soil;

Task ID 37 – 3 points

The common part of the question for all variants:

Clubroot is an infectious plant disease caused by *Plasmodiophora brassicae* Woronin. It affects important agricultural crops: cabbage (*Brassica oleracea* L.), turnips (*Brassica rapa* L.), mustard (*Sinapis* sp.) and other plants of the Family Cruciferae, or Brassicaceae. The figure below shows the life cycle of *P. brassicae*. "N" stands for haploid stage, "2N" stands for diploid stage, and "R!" - reduction division.

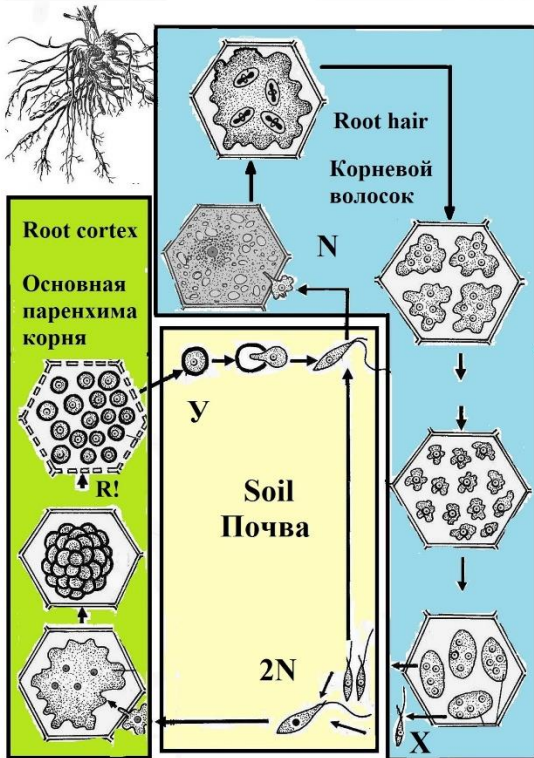

Analyze presented scheme and determine which of the statements are true or false:

Variant 1:

- A) *P. brassicae* is an intracellular parasite;
- B) *P. brassicae* and representatives of collar flagellates (*Choanoflagellata Cavalier-Smith*) are evolutionarily more related to each other than to human (*Homo sapiens* L.);
- C) Infection of the plant with *P. brassicae* is always accompanied by the proliferation of cells of the primary cortex;
- D) There is always a sequential change of sexual and asexual reproduction in the life cycle of pathogen;
- E) *P. brassicae* gametes are formed in the cells of the root hair;
- F) The cyst of *P. brassicae*, indicated in the figure with the letter Y, is diploid;

Variant 2:

- A) *P. brassicae* and representatives of collar flagellates (*Choanoflagellata Cavalier-Smith*) are evolutionarily more related to each other than to human (*Homo sapiens* L.);
- B) There is always a sequential change of sexual and asexual reproduction in the life cycle of pathogen;
- C) Structures X provide for both sexual and asexual reproduction of the organism;
- D) *P. brassicae* gametes are formed in the cells of the root hair;
- E) The cyst of *P. brassicae*, indicated in the figure with the letter Y, is diploid;
- F) High humidity is one of the factors that increase the incidence of clubroot;

Variant 3:

- A) The pathogen affects only the cells of the plant root system;
- B) There is always a sequential change of sexual and asexual reproduction in the life cycle of pathogen;
- C) Fertilization of *P. brassicae* occurs in the cells of the root hair;
- D) *P. brassicae* is characterized by isogamy;
- E) The *P. brassicae* zygote is mobile, it has a flagellum;
- F) High humidity is one of the factors that increase the incidence of clubroot;

Task ID 38 – 3 points

The common part of the question for all variants:

The life cycle of Cnidaria consists of two generations: sexual generation and asexual generation.

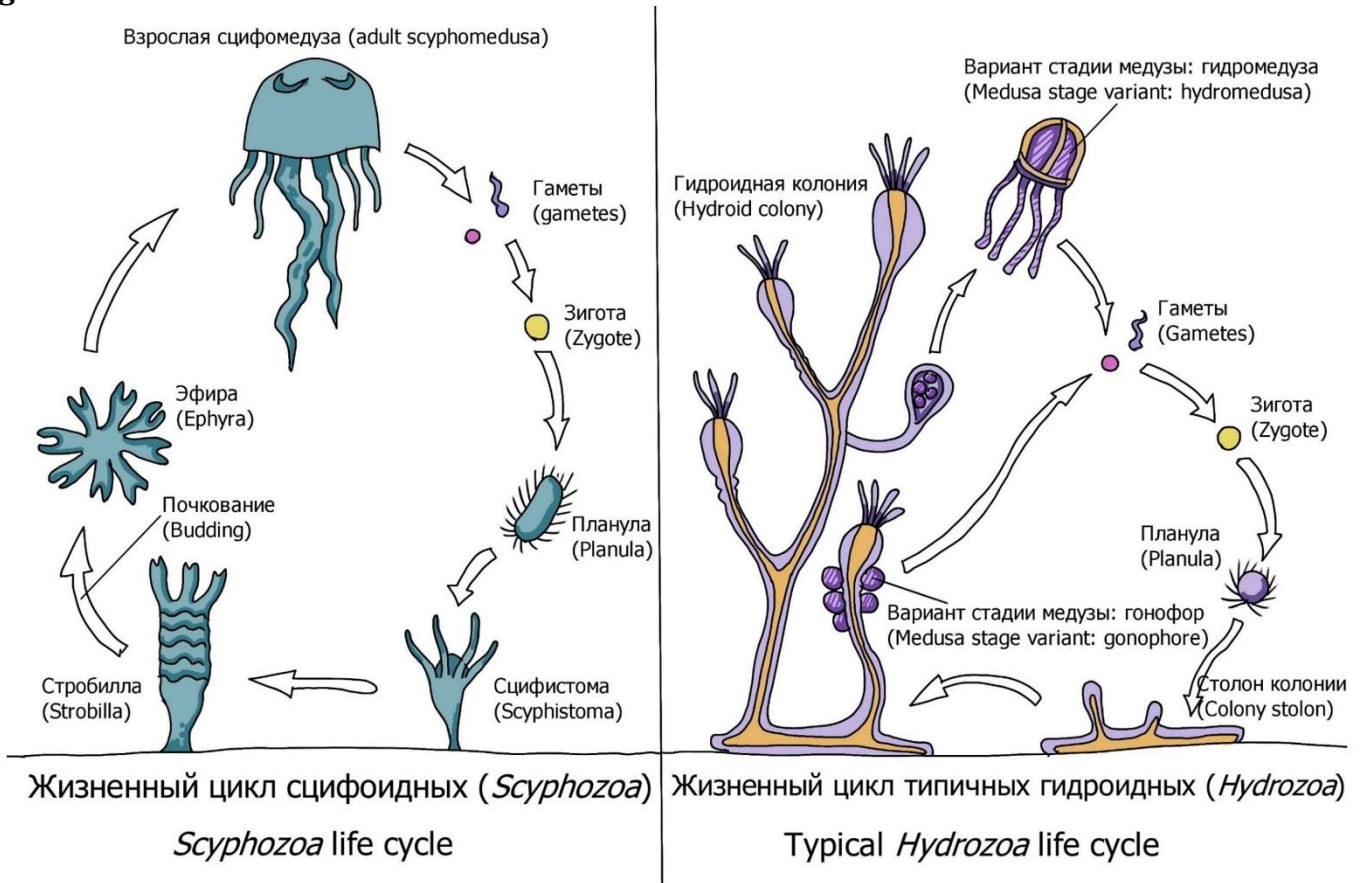

Below is a list of the stages of the life cycle of various representatives in the clade Medusozoa, phylum Cnidaria. Mark «true» those stages that belong to the sexual generation — the generation that can reproduce sexually. Mark the rest as «false»:

Variant 1:

- A) Planula – ciliated larva;
- B) Scyphistome – a scyphoid polyp;
- C) Ephyra – a recently budded medusa;
- D) Scyphomedusa;
- E) Stolon of the hydroid colony;
- F) Zygote from a fertilized medusa egg;

Variant 2:

- A) Planula – ciliated larva;
- B) Strobilla – a budding scyphoid polyp;
- C) Ephyra – a recently budded medusa;
- D) Hydroid colony;
- E) Hydromedusa;
- F) Zygote from a fertilized medusa egg;

Variant 3:

- A) Planula – ciliated larva;
- B) Scyphistome – a scyphoid polyp;
- C) Hydroid colony;

- D) Gonophores – a reduced hydromedusa stage;
- E) Stolon of the hydroid colony;
- F) Zygote from a fertilized medusa egg;

Task ID 39 – 3 points

The common part of the question for all variants:

The ancestors of molluscs had a developed secondary body cavity – coelom. The coelom is formed from specialized mesodermal cells – teloblasts – as a result of their division and the subsequent formation of cavities within the formed groups of cells. The majority of contemporary molluscs have a reduced coelom. Nonetheless, the vestiges of coelom had remained in some organs in modern molluscs.

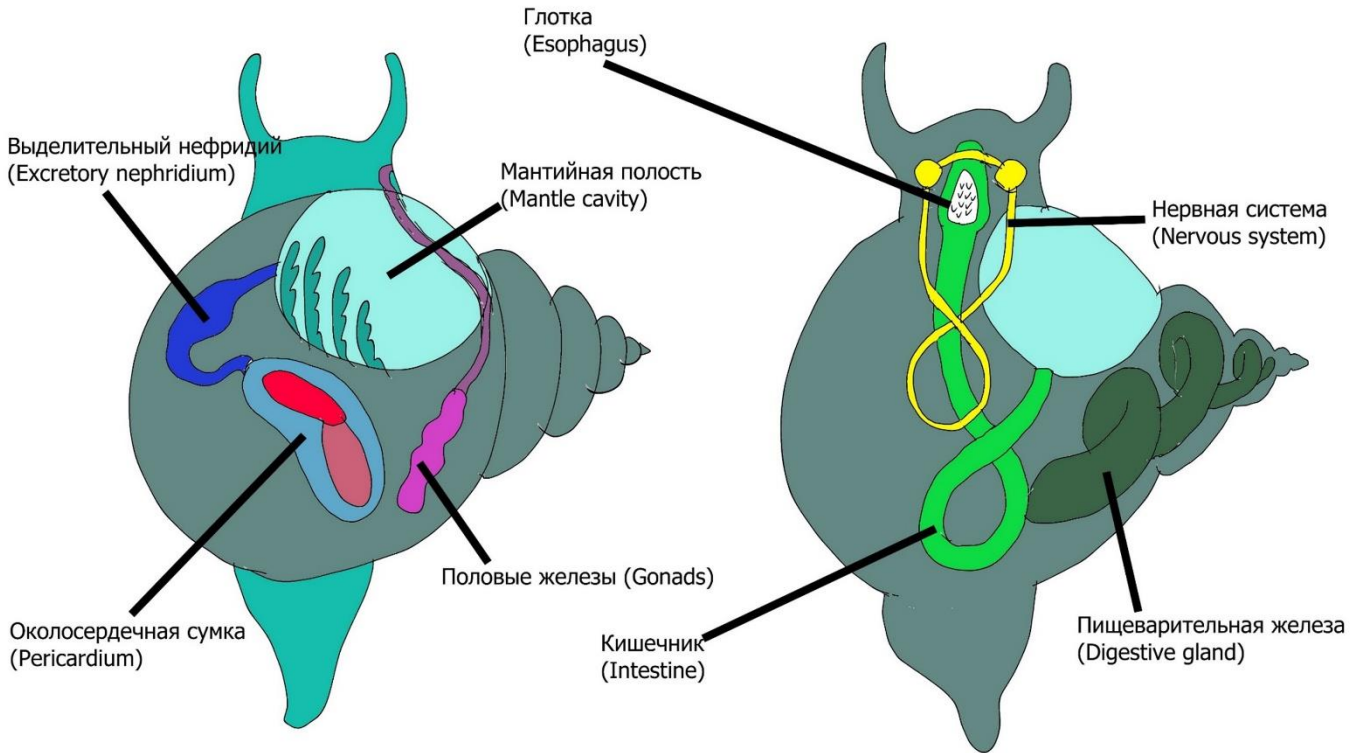

Mark «true» those of the specified organs of the molluscs that are derived from the coelom or have a connection with the coelom. Mark the rest as «false»:

Variant 1:

- A) Pericardium;
- B) Mantle cavity;
- C) The intestine;
- D) Esophagus;
- E) Excretory system;
- F) Reproductive system;

Variant 2:

- A) Pericardium;
- B) Mantle cavity;
- C) The intestine;
- D) Esophagus;
- E) Digestive gland;
- F) Pedal ganglia;

Variant 3:

- A) Pericardium;
- B) Mantle cavity;
- C) The intestine;
- D) Esophagus;

- E) Esophageal nerve ring;
- F) Visceral ganglia;

Task ID 40 – 3 points

Common part of the question for all variants:

Lemmings (*Lemmini sp.*) are rodents from the *Cricetidae* family. Their population is characterized by constant fluctuations in numbers (see charts below). Until the 70s of the XX century, there was a myth about the "altruistic suicide" of lemmings. Scientists explained this by the fact that with a strong increase in numbers, a group of lemmings, following the "leader", rush into the sea to make way for their relatives. But a detailed long-term study, which was conducted from the 70s to the end of the 90s, showed that the increase in the mortality of lemmings has nothing to do with altruism. The left graph shows the lemming catch rate for different years, which roughly reflects the number of rodents. The real count of lemmings in the field is marked in red, the theoretical count is in black. In the right graph, the corresponding catch rate for Arctic foxes (*Vulpes lagopus*).

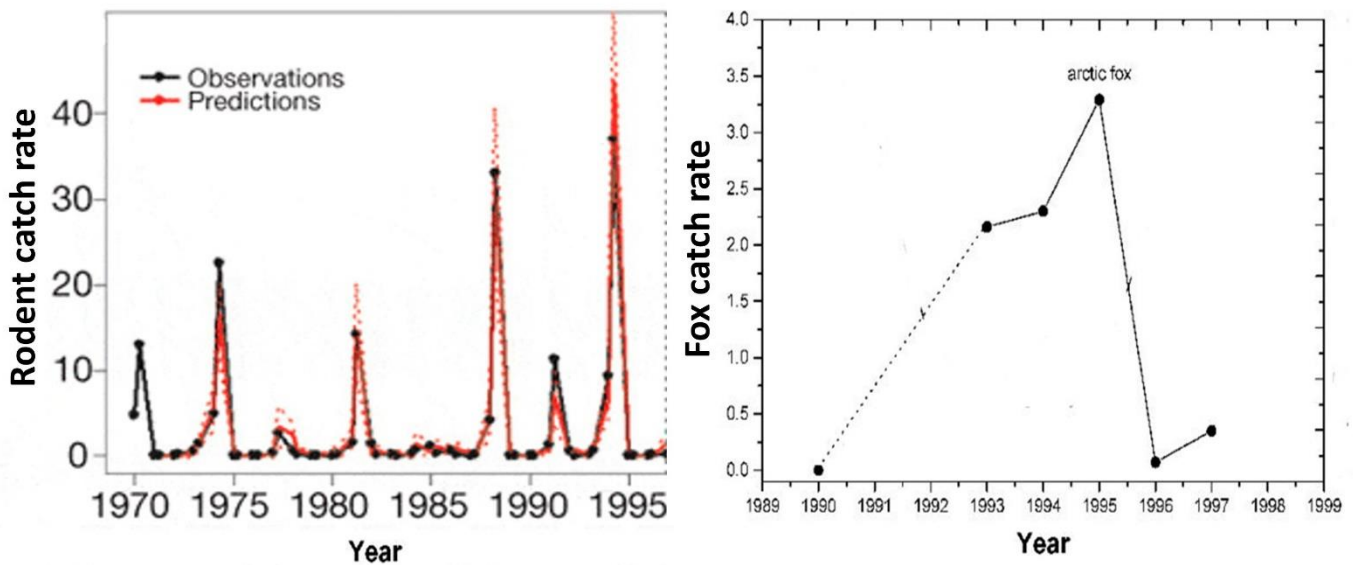

Based on the analysis of the graphs, as well as knowledge of the biology of these organisms, for each of the following statements, indicate whether it is true or false:

Variant 1:

- The increased mortality of lemmings is associated with an increase in their population;
- Lemmings don't throw themselves into the water on purpose. Lemmings die while searching for food resources and accidentally fall into the sea;
- The oldest individuals rush into the water to free up territories and resources for younger lemmings;
- Lemmings are the main food resource of Arctic foxes (*Vulpes lagopus*);
- Lemmings are solitary animals. When they settle a new territory in a large group in search of food and their fall into the water – it is associated only with a very high density and lack of food and territorial resources;
- Population dynamics of the lemming population is an example of autocorrelation: future abundance depends on abundance in previous years;

Variant 2:

- Lemmings don't throw themselves into the water on purpose. Lemmings die while searching for food resources and accidentally fall into the sea;
- Food and territorial resources are enough for all lemmings and the decline in numbers is associated only with aging of individuals and natural death;
- Lemmings are the main food resource of Arctic foxes (*Vulpes lagopus*);

- D) Lemmings lead a social lifestyle with a complex family structure, so they move in search of food in a family group;
- E) Population dynamics of the lemming population is an example of autocorrelation: future abundance depends on abundance in previous years;
- F) The increase in the number of Arctic foxes (*Vulpes lagopus*) is associated with the high number of lemmings;

Variant 3:

- A) Lemmings don't throw themselves into the water on purpose. Lemmings die while searching for food resources and accidentally fall into the sea;
- B) During fertile seasons, the lemming population increases dramatically;
- C) Lemmings are the main food resource of Arctic foxes (*Vulpes lagopus*);
- D) Population dynamics of the lemming population is an example of autocorrelation: future abundance depends on abundance in previous years;
- E) The number of lemmings defies any rules of population ecology - it is a random process;
- F) The number of lemmings does not affect the population of Arctic foxes (*Vulpes lagopus*);

Task ID 41 – 3 points

Common part of the question for all variants:

Whales can dive deep. A blue whale (*Balaenoptera musculus*), for example, can dive up to 540 m. But during the diving, decompression sickness inevitably occurs. It occurs due to the fact that with increasing pressure, the solubility of nitrogen in body fluids becomes greater. Because of this, during a rapid ascent, the blood foams due to the fact that previously dissolved nitrogen passes into a gaseous form and forms bubbles that damage the walls of the vessels. However, whales deal with this problem. The same principle is used by other diving animals, including seals and diving ducks.

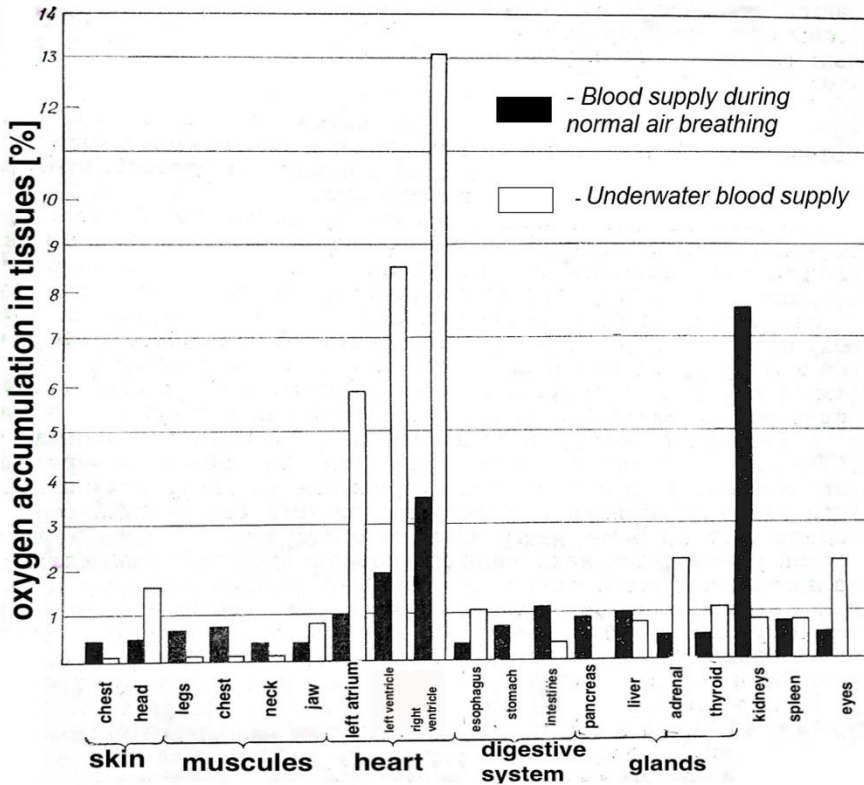

Examine the graph above and mark «true» for the statements below, corresponding to real-life adaptations that help «divers» cope with decompression sickness and oxygen deprivation in the aquatic environment. Mark the rest of the statements as «false»:

Variant 1:

- A) When diving, whales narrow the lumens of blood vessels in all organs, except for the brain and heart, which constantly need oxygen. At this moment, blood doesn't flow to the rest of the body, but they organs are protected from nitrogen bubbles;
- B) Physiologically, nothing changes: whales do not protect their organs from nitrogen in any way and only when they float up, they get rid of bubbles;
- C) When diving, whales continue to breathe and filter oxygen from the water;
- D) During diving, the muscles of the animals switch to anaerobic regime and lactic acid accumulates due to the lack of blood flow;
- E) During diving, the heart rate slows down to 4-8 beats per minute;
- F) Whale metabolism decreases with diving;

Variant 2:

- A) When diving, whales narrow the lumens of blood vessels in all organs, except for the brain and heart, which constantly need oxygen. At this moment, blood doesn't flow to the rest of the body, but they organs are protected from nitrogen bubbles;

- B) Physiologically, nothing changes: whales do not protect their organs from nitrogen in any way and only when they float up, they get rid of bubbles;
- C) To prevent hypoxia in the tissues of organs (lack of oxygen in the tissues) during diving, myoglobin molecules retain oxygen through effective binding;
- D) Heart rate increases during swimming underwater up to 40 beats per minute;
- E) Whale metabolism decreases with diving;
- F) Muscles need oxygen when diving and receive more oxygen than all other organs;

Variant 3:

- A) When diving, whales narrow the lumens of blood vessels in all organs, except for the brain and heart, which constantly need oxygen. At this moment, blood doesn't flow to the rest of the body, but they organs are protected from nitrogen bubbles;
- B) Physiologically, nothing changes: whales do not protect their organs from nitrogen in any way and only when they float up, they get rid of bubbles;
- C) To prevent hypoxia in the tissues of organs (lack of oxygen in the tissues) during diving, myoglobin molecules retain oxygen through effective binding;
- D) When diving, whales continue to breathe and filter oxygen from the water;
- E) Whale metabolism decreases with diving;
- F) Muscles need oxygen when diving and receive more oxygen than all other organs;

Task ID 42 – 3 points

Common part of the question for all variants:

The diagram shows a smooth muscle cell of a blood vessel wall and an adjacent endothelial cell.

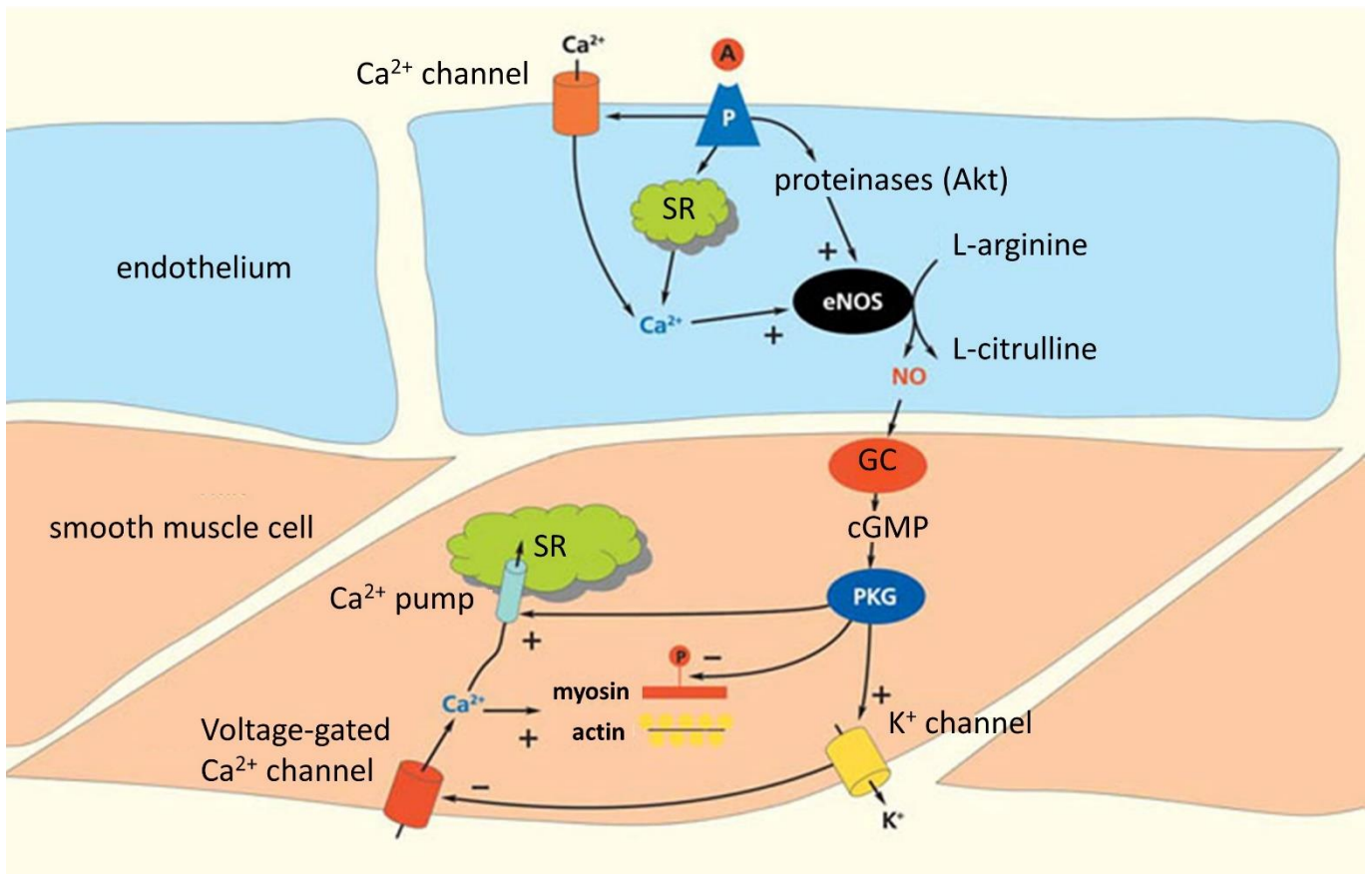

Legend: A - acetylcholine, SR - sarcoplasmic reticulum, eNOS - endothelial NO synthase, NO - nitric oxide (II), GC - guanylate cyclase, cGMP - cyclic guanosine monophosphate, PKG - protein kinase G, P – receptor. A plus at the end of the arrow is an activating effect, a minus at the end of an arrow is an inhibitory effect.

For each of the following statements, indicate whether it is true or false:

Variant 1:

- A) When acetylcholine appears in the bloodstream, the vessel lumen narrows;
- B) When the endothelium is removed, the effect of acetylcholine will be the same as in an intact vessel;
- C) Nitric oxide (II) plays a role in the regulation of filtration and reabsorption processes;
- D) Activation of the parasympathetic nervous system leads to the activation of NO synthase;
- E) Depolarization of the endothelial cell leads to hyperpolarization of the smooth muscle cell;
- F) Activation of endothelial potassium channels leads to the activation of voltage-gated calcium channels in smooth muscle cells;

Variant 2:

- A) When acetylcholine appears in the bloodstream, the vessel lumen narrows;
- B) Nitric oxide (II) plays a role in the regulation of filtration and reabsorption processes;
- C) Activation of smooth muscle contraction occurs when Ca²⁺ ions enter the smooth muscle cell only from the SR;
- D) Activation of the sympathetic nervous system leads to the activation of NO synthase;
- E) Depolarization of the endothelial cell leads to hyperpolarization of the smooth muscle cell;

F) Activation of endothelial calcium channels leads to activation of potassium channels in smooth muscle cells.

Variant 3:

A) Activation of NO synthase leads to an increase in the level of cyclic forms of nucleotides in a smooth muscle cell;

B) When the endothelium is removed, the effect of acetylcholine will be the same as in an intact vessel;

C) Activation of smooth muscle contraction occurs when Ca^{2+} ions enter the smooth muscle cell only from the SR;

D) Activation of the sympathetic nervous system leads to the activation of NO synthase;

E) Depolarization of the endothelial cell leads to hyperpolarization of the smooth muscle cell;

F) Activation of endothelial potassium channels leads to the activation of voltage-gated calcium channels in smooth muscle cells;

Task ID 44 – 3 points

Common part of the question for all variants:

Ion distribution across the plasma membrane is unequal. For example, potassium ions are at a much higher concentration in the cytoplasm than in the extracellular fluid, whereas the reverse is true for sodium ions. This is due to the work of Na,K-ATPase which extrudes 3 sodium ions from and imports 2 potassium ions into the cell per cycle.

Suppose that cell membrane is permeable only to potassium ions. These ions will move outward along their concentration gradient. Anions that are incapable of crossing the membrane will accumulate inside the cell membrane, whereas outward potassium ion current will lead to excess of positive charge outside the membrane. Charge separation generates electrical potential gradient across the membrane, which will counterbalance the concentration gradient. At equilibrium, these two forces will be equal to each other and net potassium current will be zero. The membrane potential at this state is called *equilibrium potential* for potassium ions.

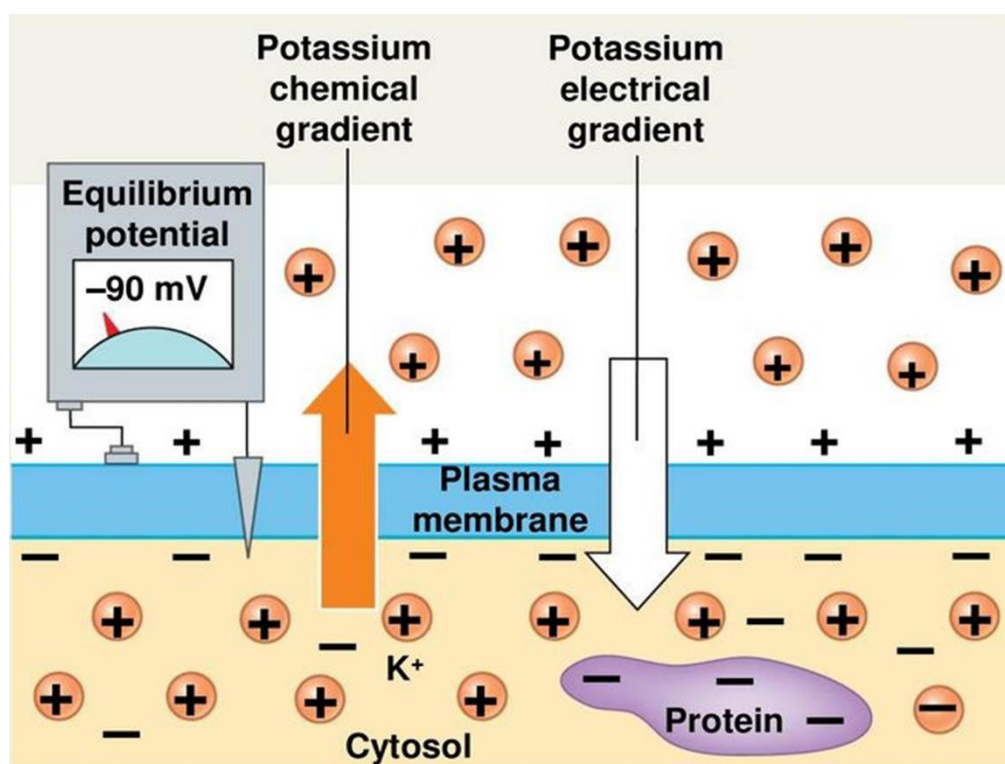

You conduct an electrophysiological study on a single isolated axon. The table below shows extra- and intracellular concentrations of sodium and potassium levels as well as equilibrium potential at $T=293\text{K}$.

Ions	Extracellular concentration, mmol/L	Intracellular concentration, mmol/L	Equilibrium potential, mV
Potassium	4	150	-91
Sodium	140	4	+90

Axonal membrane potential is -70 mV . Movement of a membrane potential to a more negative value is called hyperpolarization. Depolarization is the opposite of hyperpolarization (i.e. membrane potential becomes less negative/more positive). For simplicity one can assume that this membrane is only permeable to sodium and potassium ions.

For each of the following statements, indicate whether it is true or false:

Variant 1:

- A) An increase in potassium ion permeability will not change potassium equilibrium potential;
- B) At rest axolemma is more permeable to sodium ions than to potassium ions;
- C) If one blocks Na/K-ATPase, extra- and intracellular sodium ion concentrations will become equal;
- D) A 10-fold increase in sodium ion permeability will result in membrane depolarization;
- E) A 10-fold increase in potassium ion permeability will result in membrane hyperpolarization;
- F) A 10-fold increase in extracellular potassium ion concentration will result in membrane depolarization;

Variant 2:

- A) An increase in potassium ion permeability will not change potassium equilibrium potential;
- B) At rest axolemma is more permeable to potassium ions than to sodium ions;
- C) If one blocks Na/K-ATPase, extra- and intracellular sodium ion concentrations will become equal;
- D) A 10-fold increase in sodium ion permeability will result in membrane hyperpolarization;
- E) A 10-fold increase in potassium ion permeability will result in membrane depolarization;
- F) A 10-fold increase in intracellular sodium ion concentration will result in membrane depolarization;

Variant 3:

- A) An increase in potassium ion permeability will not change potassium equilibrium potential;
- B) At rest axolemma is more permeable to potassium ions than to sodium ions;
- C) If one blocks Na/K-ATPase, extra- and intracellular sodium ion concentrations will become equal;
- D) A 10-fold increase in sodium ion permeability will result in membrane hyperpolarization;
- E) A 10-fold increase in potassium ion permeability will result in membrane depolarization;
- F) A 10-fold increase in extracellular potassium ion concentration will result in membrane depolarization;

Task ID 46 – 3 points

Common part of the question for all variants:

Biochemical pathway of purine synthesis is a great example to study principles of feedback regulation. Concentration of AMP and GMP is tightly regulated to meet the needs of the cell. The scheme below represents some parts of purine synthesis. Black arrows denote chemical reaction whereas dash lines with red lines in the end represent negative regulation. Abbreviations: PRPP - 5-Phosphoribosyl-1-pyrophosphate, IMP - Inosinate, AdSuc - Adenylosuccinate, XMP - Xanthylate, GPA, AC and ID - enzymes involved in the pathway.

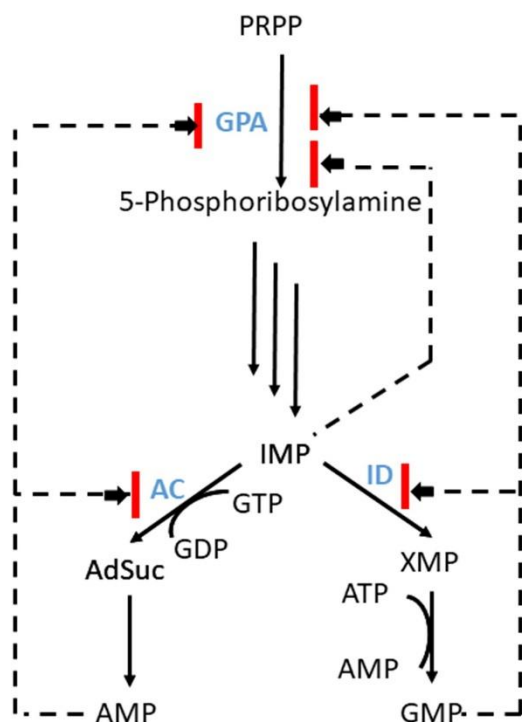

Analyze presented scheme and determine which of the statements are true or false:

Variant 1:

- A) Increase in the AMP and ATP concentration activates synthesis of GMP;
- B) Change in AMP concentration does not affect the rate of GMP synthesis;
- C) Inhibition of purine synthesis is more prominent when both AMP and GMP concentrations increase;
- D) GMP inhibits ID activity;
- E) High concentration of GMP inhibits AC;
- F) A high concentration of AMP blocks the work of ID, and an increase in the concentration of HMP inhibits AS.

Variant 2:

- A) Increase in the GMP and GTP concentration activates synthesis of AMP;
- B) Change in AMP concentration does not affect the rate of GMP synthesis;
- C) AMP inhibits AC activity;
- D) The accumulation of AMP and GMP in the cell leads to an increase in the concentration of IMP, which inhibits the synthesis of all purine nucleotides;
- E) Purine synthesis is regulated by positive feedback loops;
- F) A high concentration of AMP blocks the work of ID, and an increase in the concentration of HMP inhibits AS.

Variant 3:

- A) Increase in the AMP and ATP concentration activates synthesis of GMP;

- B) Inhibition of purine synthesis is more prominent when both AMP and GMP concentrations increase;
- C) GMP inhibits ID activity;
- D) AdSuc and XMP branches compete for IMP;
- E) High concentration of GMP inhibits AC;
- F) Purine synthesis is regulated by positive feedback loops;

Task ID 48 – 3 points

The common part of the question for all variants:

You are studying protein “X” and plan to use CRISPR-Cas technology to edit the gene “X” that encodes it. To edit the genome using the CRISPR-Cas system, it is necessary to select a guide RNA (gRNA or sgRNA) to direct the complex to a specific genome sequence (target DNA) and an endonuclease Cas (CRISPR-associated protein, Cas nuclease).

The guide RNA must be complementary to the region of the genome to which the defined PAM sequence (proto-spacer adjacent motif) is adjacent. Cas9 from *Streptococcus pyogenes* (Cas9 nuclease) recognizes the PAM sequence 5'-NGG-3', Cas12a from *Lachnospiraceae bacterium* (Cas12a nuclease) recognizes the PAM sequence 5'-TTTN-3', where N is any nucleotide, and then endonuclease Cas makes a double-strand break in DNA (cleavage). The location of the PAM sequences in relation to the target DNA and guide RNA is shown in the figure below.

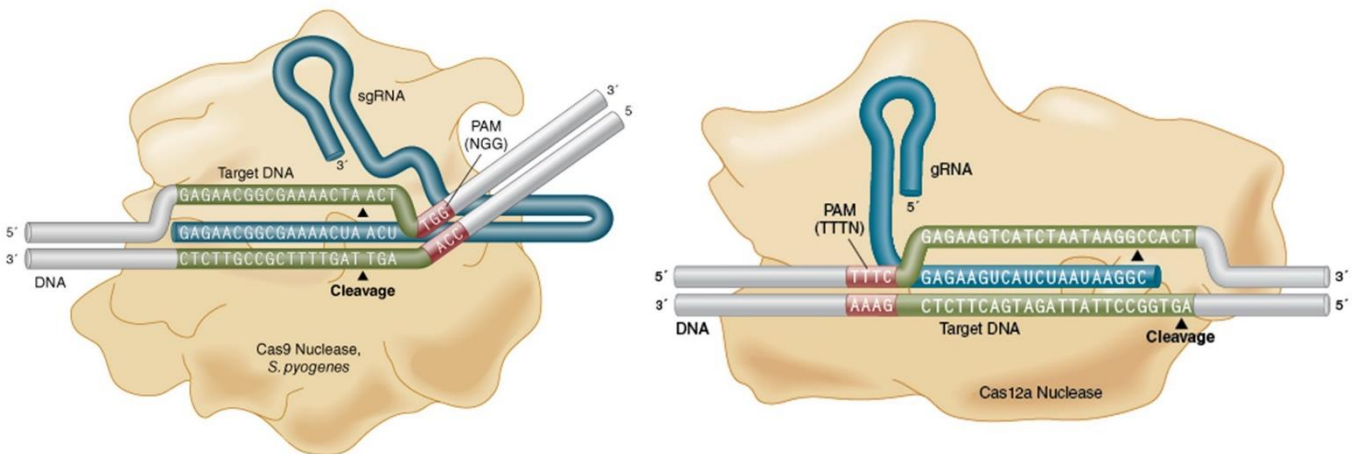

The sequence of genomic DNA at the border of exon 3 and intron 4 (underlined) of gene “X” is shown below. It is a sequence of the genomic DNA strand that is depicted at the top in the figure in complex with gRNAs and Cas nucleases:

5'
CGCGGTCTTTCCACGAGCTCTCCACGGGGAGGAGGGGAAAACTGCTGAAGAGCTTTCAGGTAAGTG
GCTGTTTCGGAGAGACCTCATCTAGTCGCTGGCCTCGTCAAGG 3'

For each of the following statements, indicate whether it is true or false:

Variant 1:

- A) As a result of the site-directed double-strand break in DNA induced by a Cas nuclease and subsequent repair by the mechanism of non-homologous end joining (NHEJ), a frame shift may occur that leads to the target gene knockout;
- B) A researcher can use a guide RNA with a nucleotide sequence of 5'-CUUCCACGAGCUCUCCACG-3' and Cas9 nuclease for the knockout of the target gene “X”;
- C) A researcher can use a guide RNA with a nucleotide sequence of 5'-GGGAAAACUGCUGAAGAGC-3' and Cas12a nuclease for the knockout of the target gene “X”;
- D) A researcher can use a guide RNA with a nucleotide sequence of 5'-GAGAGACCUCAUCUAGUCGC-3' and Cas9 nuclease for the knockout of the target gene “X”;
- E) A researcher can use a guide RNA with a nucleotide sequence of 5'-CACGAGCUCUCCACGGGGAG-3' and Cas12a nuclease for the knockout of the target gene “X”;
- F) As a result of the site-directed double-strand break in DNA induced by a Cas nuclease and subsequent repair by the mechanism of homologous recombination (HDR), the target gene “X” can be changed so that it encodes the target protein X fused to the fluorescent protein EGFP.

Variant 2:

- A) As a result of the site-directed double-strand break in DNA induced by a Cas nuclease and subsequent repair by the mechanism of non-homologous end joining (NHEJ), a frame shift may occur that leads to the target gene knockout;
- B) A researcher can use a guide RNA with a nucleotide sequence of 5'-GGGGAAAACUGCUGAAGAGC-3' and Cas12a nuclease for the knockout of the target gene "X";
- C) A researcher can use a guide RNA with the nucleotide sequence 5'-UCUAGUCGCUGGCCUCGUCA-3' and Cas9 nuclease for the knockout of the target gene "X";
- D) A researcher can use a guide RNA with the nucleotide sequence 5'-AAAACUGCUGAAGAGCUUUC-3' and Cas9 nuclease for the knockout of the target gene "X";
- E) Guide RNA should contain not only regions complementary to the target DNA sequence, but also the transactivator part for the interaction with Cas9 nuclease;
- F) A researcher can use a guide RNA to the promoter of the target gene "X" and Cas9 modified protein with inactivated nuclease domain fused with a transcription activator domain (dCas9-VP64) to activate expression of the gene "X" using CRISPR-Cas technology;

Variant 3:

- A) As a result of the site-directed double-strand break in DNA induced by a Cas nuclease and subsequent repair by the mechanism of non-homologous end joining (NHEJ), a frame shift may occur that leads to the target gene knockout;
- B) A researcher can use a guide RNA with a nucleotide sequence of 5'-CUUUCCACGAGCUCUCCACG-3' and Cas9 nuclease for the knockout of the target gene "X";
- C) A researcher can use a guide RNA with the nucleotide sequence 5'-UCUAGUCGCUGGCCUCGUCA-3' and Cas9 nuclease for the knockout of the target gene "X";
- D) Guide RNA should contain not only regions complementary to the target DNA sequence, but also the transactivator part for the interaction with Cas9 nuclease;
- E) A researcher can use a guide RNA with the nucleotide sequence 5'-UCUUUCCACGAGCUCUCCAC-3' and Cas9 nuclease for the knockout of the target gene "X";
- F) A researcher can use a guide RNA with a nucleotide sequence of 5'-GGAGAGACCUCAUCUAGUCG-3' and Cas12a nuclease for the knockout of the target gene "X";

Task ID 50 – 3 points

The common part of the question for all variants:

Cell death is an important process for organism functioning, disturbances in which lead to various diseases. There are two main morphological types of cell death – apoptosis and necrosis. Apoptosis characteristics are chromatin condensation, nucleus fragmentation and apoptotic bodies production. These bodies are phagocytosed by neighboring cells. Necrosis characteristics are the uncontrolled release of cellular contents into the microenvironment and inflammatory response triggering.

Fluorescent dye Annexin V-FITC stains phosphatidylserine. In normal conditions phosphatidylserine is located on the inner surface of the plasma membrane and is not available for staining. Its appearance on the outer surface of the plasma membrane is an apoptosis marker. This is typical both for still living apoptotic cells and for cells that have died as a result of this type of death.

Another fluorescent dye, propidium iodide (PI), stains DNA. It is also unable to permeate into living cells. The method of flow cytometry allows count cells stained by one of these dyes or both of them. It allows distinguishing apoptotic and necrotic cell death.

You want to study the effect of compounds A and B in cell death using this method. Here you can see the result of such experiment:

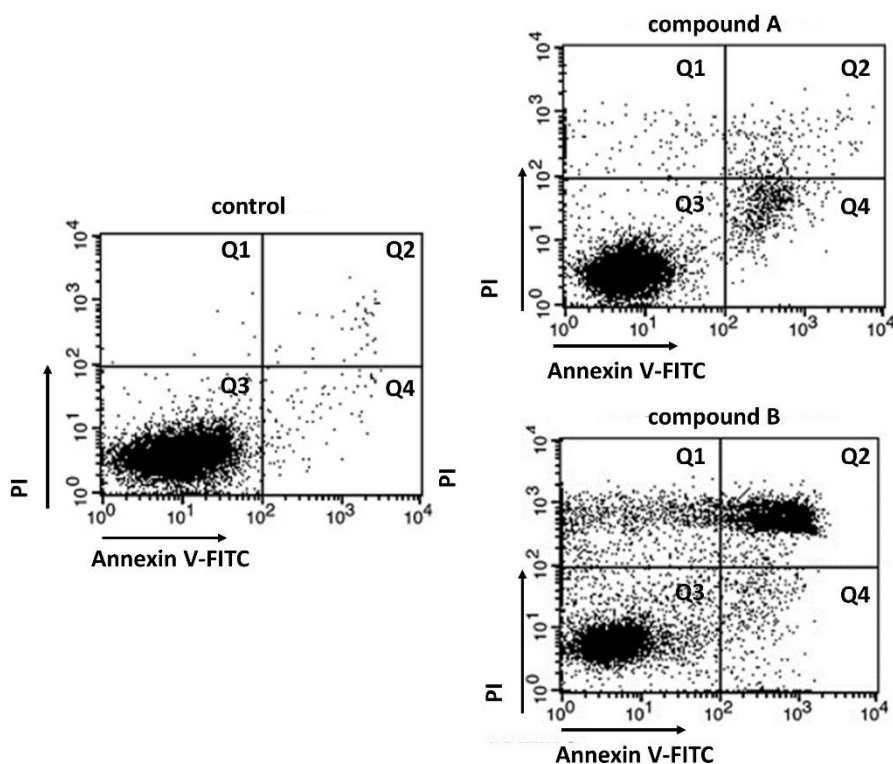

Every point on graphs corresponds to the fluorescence of two dyes from one cell. The abscissa shows the Annexin V-FITC fluorescence intensity, the ordinate shows the PI fluorescence intensity. Cells can be divided into four populations (Q1 - Q4) corresponding to different forms of cell death.

For each of the following statements indicate whether it is true or false:

Variant 1:

- A) Q3 population consists of cells weakly stained by both dyes;
- B) Q1 population consists of living cells;
- C) Apoptotic cells are in Q1 и Q3 populations;
- D) This method does not allow distinguish early apoptotic cells (still living) and late apoptotic cells (dead);

- E) After compound A treatment cells die mostly from necrosis;
- F) Compound B causes more intensive cell death than compound A.

Variant 2:

- A) Q3 population consists of cells weakly stained by both dyes;
- B) Q2 population consists of living cells;
- C) Apoptotic cells are in Q1 и Q3 populations;
- D) This method does not allow distinguish early apoptotic cells (still living) and late apoptotic cells (dead);
- E) After compound A treatment cells die mostly from apoptosis;
- F) Compound B causes more intensive cell death than compound A.

Variant 3:

- A) Q2 population consists of cells highly stained by both dyes;
- B) Q3 population consists of living cells;
- C) Apoptotic cells are in Q2 и Q4 populations;
- D) This method does not allow distinguish early apoptotic cells (still living) and late apoptotic cells (dead);
- E) After compound A treatment cells die mostly from necrosis;
- F) Compound A causes more intensive cell death than compound B;

Task ID 52 – 3 points

The common part of the question for all variants:

Lac operon on *Escherichia coli* is a classical model for gene expression regulation in bacteria. In *E. coli* gene *lacI* codes repressor protein. The protein product of *lacI* binds the operator, when not bound with lactose. But when there is free lactose in the cell, it is binded by the repressor causing complex dissociation from the operator. *LacZ* gene encodes β -galactosidase enzyme. Let's assume that *lacI* and *lacZ* gene mutations shut down their protein synthesis. Mutations in promoter and operator destroy protein interactions with these sites. The CAP protein is activated when the level of cAMP in the cell increases due to starvation (in the absence of glucose), which leads to its binding to the CAP site. There is no β -galactosidase synthesis without active CAP-protein. P and O in the diagram below represent, respectively, a promoter and an operator.

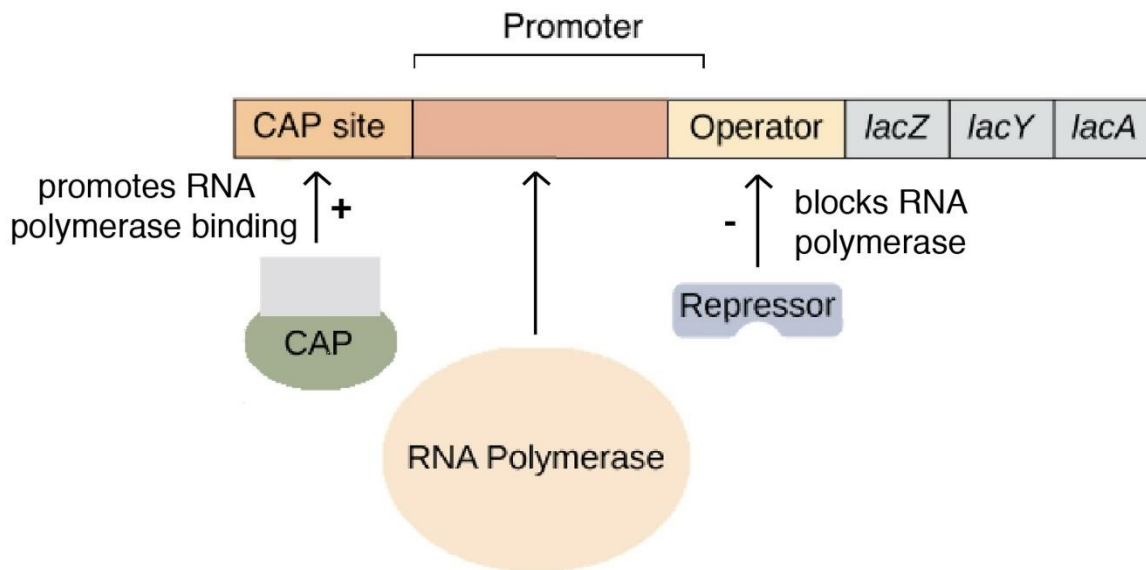

Mark as «true» the conditions under which β -galactosidase enzyme will be synthesized in *E. coli* cells. Mark the rest of the conditions as «false»:

Variant 1:

- A) NO mutations, glucose in environment, lactose in environment;
- B) NO mutations, NO glucose in environment, lactose in environment;
- C) *lacI* mutation, glucose in environment, lactose in environment;
- D) *lacI* mutation, NO glucose in environment, NO lactose in environment;
- E) *lacZ* mutation, NO glucose in environment, lactose in environment;
- F) O mutation, NO glucose in environment, NO lactose in environment;

Variant 2:

- A) NO mutations, glucose in environment, NO lactose in environment;
- B) NO mutations, NO glucose in environment, lactose in environment;
- C) *lacI* mutation, NO glucose in environment, lactose in environment;
- D) O mutation, glucose in environment, lactose in environment;
- E) NO mutations, NO glucose in environment, NO lactose in environment;
- F) P mutation, NO glucose in environment, lactose in environment;

Variant 3:

- A) NO mutations, NO glucose in environment, lactose in environment;
- B) *lacI* mutation, glucose in environment, lactose in environment;

- C) lacI mutation, NO glucose in environment, lactose in environment;
- D) O mutation, glucose in environment, lactose in environment;
- E) lacI mutation, NO glucose in environment, NO lactose in environment;
- F) lacZ mutation, glucose in environment, lactose in environment;

Task ID 54 – 3 points

The common part of the question for all variants:

Mark «true» any statements that indicate that a population has recently been selected for a particular gene. Mark the rest of the statements as «false»:

Variant 1:

- A) Reduced nucleotide diversity in this gene;
- B) The frequency of synonymous nucleotide substitutions in this gene is higher than non-synonymous nucleotide substitutions;
- C) The frequency of non-synonymous nucleotide substitutions in this gene is higher than synonymous nucleotide substitutions;
- D) High population size;
- E) Low reproduction rate;
- F) This gene is highly conserved;

Variant 2:

- A) Reduced nucleotide diversity in this gene;
- B) The frequency of non-synonymous nucleotide substitutions in this gene is higher than synonymous nucleotide substitutions;
- C) Low population size;
- D) High reproduction rate;
- E) This gene is highly conserved;
- F) This gene encodes a protein that is not essential for survival;

Variant 3:

- A) Reduced nucleotide diversity in this gene;
- B) The frequency of non-synonymous nucleotide substitutions in this gene is higher than synonymous nucleotide substitutions;
- C) Synonymous and non-synonymous nucleotide substitutions in this gene occur with the same frequency;
- D) High population size;
- E) High reproduction rate;
- F) This gene encodes a protein that is not essential for survival;

Part C: Matching Questions

In the tasks of this part, the participants need to analyze various photographs, drawings, diagrams (marked with Arabic numerals) and compare them with elements from the two lists below (marked with Latin letters and Roman numerals). As an answer in each task, the participants must draw arrows between the elements being compared.

Grading system:

For each correctly indicated match between elements of 1 and 2 rows or 1 and 3 rows, the participant receives 0.5 points.

For each incorrect match - 0 points.

Task ID 56 – 5 points

Variant 1

The figures show the various parts of the plant organism. Determine what is shown in the figures and what main functions these parts perform:

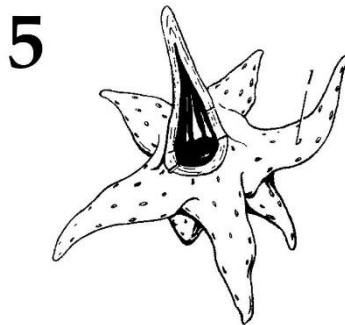
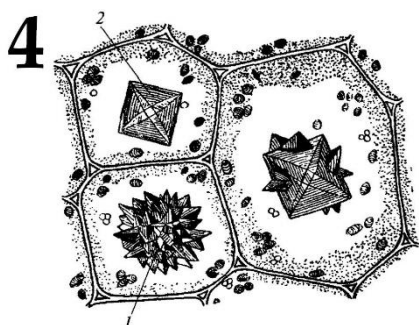
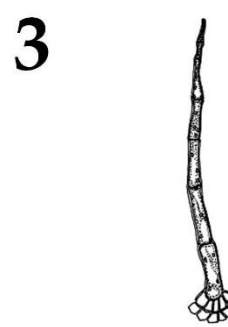
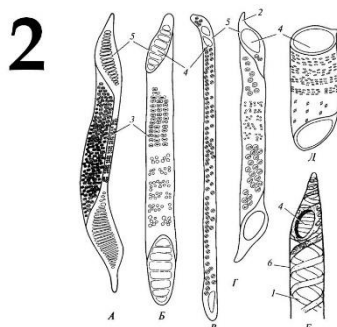
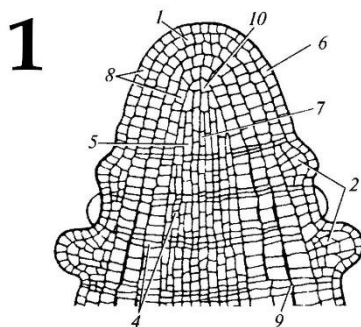

List of parts of plants (this list is redundant – it contains unnecessary names):

- A) Shoot apex;
- B) Root apex;
- C) Segments of vessels;
- D) Tracheids;
- E) Crystal-bearing cells;
- F) Covering trichome;
- G) Glandular trichome;
- H) Branched sclereid;
- I) Resin duct;
- J) Stoma;

List of main functions (this list is redundant – it contains unnecessary functions):

- I) Gas exchange and transpiration;
- II) Resin synthesis and accumulation;
- III) Mechanical function;
- IV) Accumulation of calcium oxalate;
- V) Water transport and mechanical function;
- VI) Shoot growth in length;
- VII) Root growth in length;
- VIII) Protection against overheating, excessive transpiration and eating by animals;
- IX) Secretion of essential oils, protection from excessive transpiration and eating by animals;

Answer:

Variant 1

Picture	1	2	3	4	5
Part of the plant	A	C	F	E	H
Function	VI	V	VIII	IV	III

Task ID 56 – 5 points

Variant 2

The figures show the various parts of the plant organism. Determine what is shown in the figures and what main functions these parts perform:

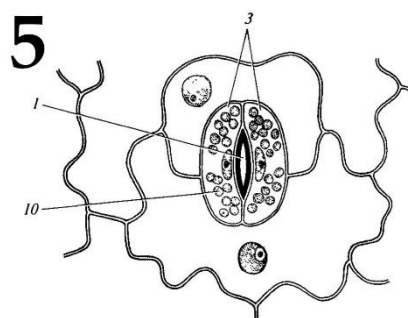
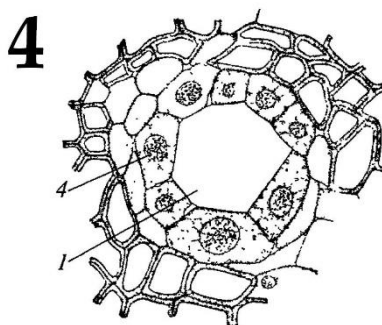
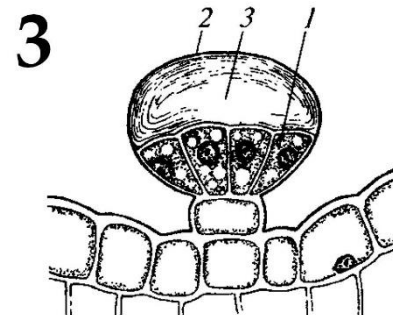
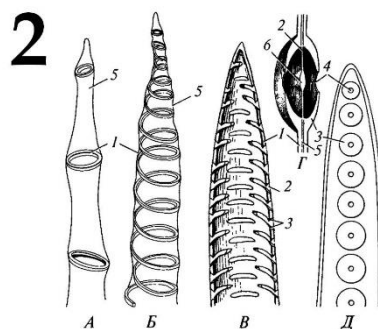
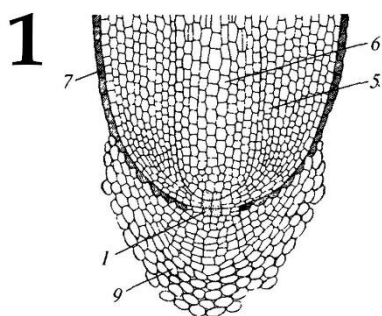

List of parts of plants (this list is redundant – it contains unnecessary names):

- A) Shoot apex;
- B) Root apex;
- C) Segments of vessels;
- D) Tracheids;
- E) Crystal-bearing cells;
- F) Covering trichome;
- G) Glandular trichome;
- H) Branched sclereid;
- I) Resin duct;
- J) Stoma;

List of main functions (this list is redundant – it contains unnecessary functions):

- I) Gas exchange and transpiration;
- II) Resin synthesis and accumulation;
- III) Mechanical function;
- IV) Accumulation of calcium oxalate;
- V) Water transport and mechanical function;
- VI) Shoot growth in length;
- VII) Root growth in length;
- VIII) Protection against overheating, excessive transpiration and eating by animals;
- IX) Secretion of essential oils, protection from excessive transpiration and eating by animals;

Answer:

Variant 2

Picture	1	2	3	4	5
Part of the plant	B	D	G	I	J
Function	VII	V	IX	II	I

Task ID 56 – 5 points

Variant 3

The figures show the various parts of the plant organism. Determine what is shown in the figures and what main functions these parts perform:

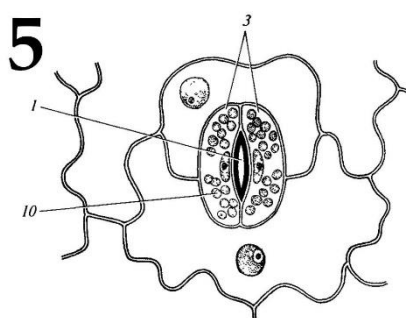
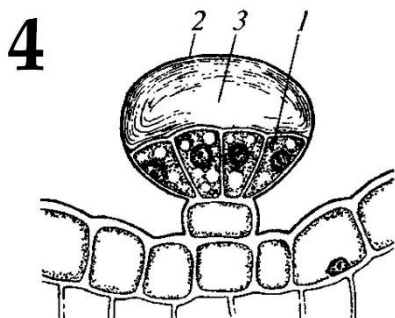
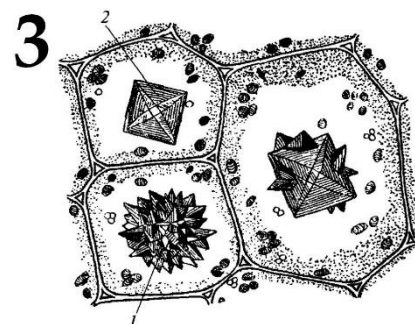
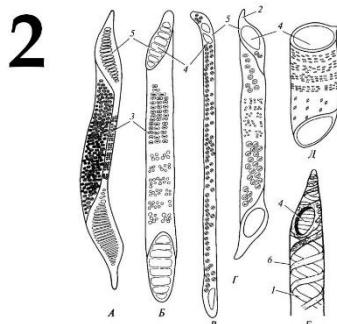
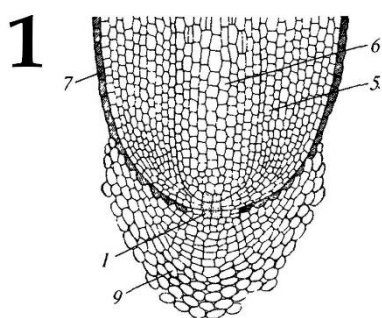

List of parts of plants (this list is redundant – it contains unnecessary names):

- A) Shoot apex;
- B) Root apex;
- C) Segments of vessels;
- D) Tracheids;
- E) Crystal-bearing cells;
- F) Covering trichome;
- G) Glandular trichome;
- H) Branched sclereid;
- I) Resin duct;
- J) Stoma;

List of main functions (this list is redundant – it contains unnecessary functions):

- I) Gas exchange and transpiration;
- II) Resin synthesis and accumulation;
- III) Mechanical function;
- IV) Accumulation of calcium oxalate;
- V) Water transport and mechanical function;
- VI) Shoot growth in length;
- VII) Root growth in length;
- VIII) Protection against overheating, excessive transpiration and eating by animals;
- IX) Secretion of essential oils, protection from excessive transpiration and eating by animals;

Answer:

Variant 3

Picture	1	2	3	4	5
Part of the plant	B	C	E	G	J
Function	VII	V	IV	IX	I

Task ID 57 – 5 points*Variant 1*

The term «spore» derives from the ancient Greek word and means “seed”. These unicellular structures produced the reproduction and dispersal of most plants and fungi. The origin and structure of spores are very diverse and different in distant taxa. The figures below show the spores of different organisms. Determine the belonging of objects to the Divisions of plants or fungi, and correlate photos with the textual descriptions.

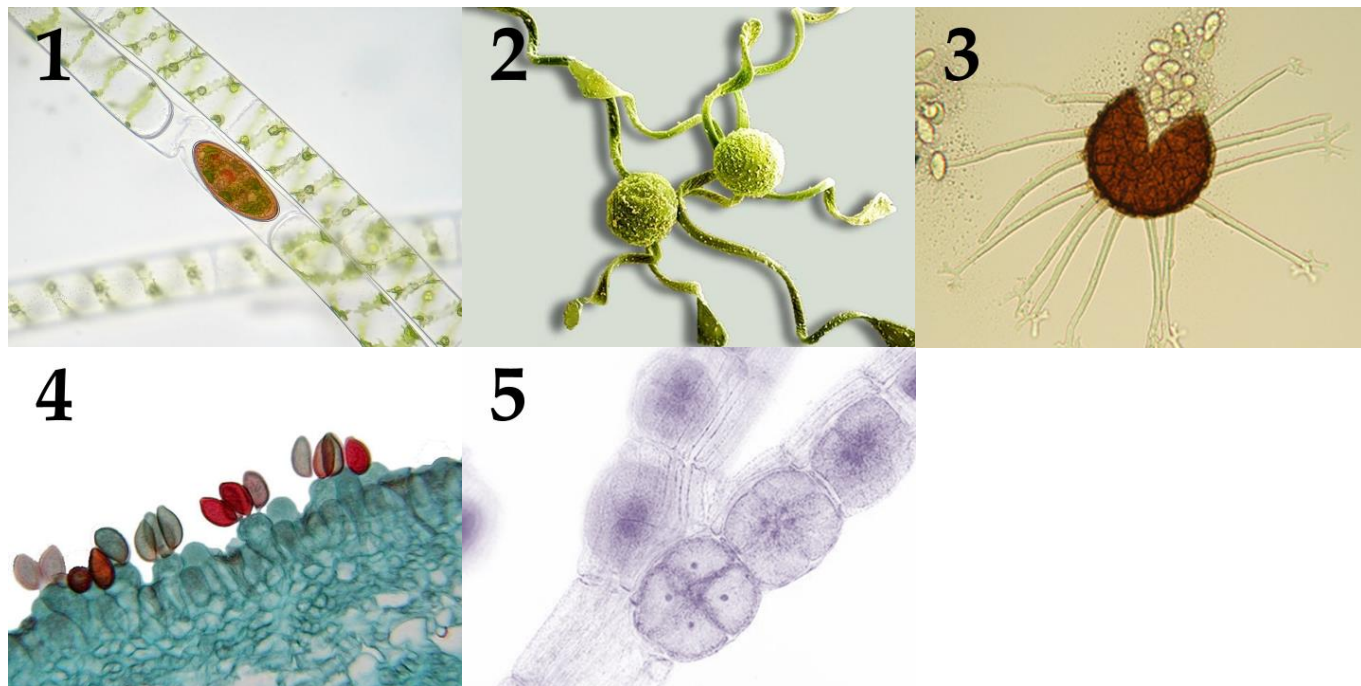

Systematic category (the list is redundant - it contains unnecessary taxa):

- A) Ascomycota;
- B) Basidiomycota;
- C) Chlorophyta (green algae);
- D) Charophyta;
- E) Ochrophyta;
- F) Rhodophyta (red algae);
- G) Bryophyta (mosses);
- H) Polypodiophyta (ferns);

List of descriptions:

- I) Haploid spores with elaters formed in the sporangium because of meiosis;
- II) Haploid spores formed exogenously because of meiosis of terminal cells of dikaryotic hyphae;
- III) Haploid spores formed by meiosis within tetrasporangium;
- IV) Diploid zygospores formed because of conjugation;
- V) Haploid spores formed endogenously within the cleistothecium;

Answer:

Variant 1

Picture	1	2	3	4	5
Systematic category	D	H	A	B	F
Description	IV	I	V	II	III

Task ID 57 – 5 points

Variant 2

The term «spore» derives from the ancient Greek word and means “seed”. These unicellular structures produced the reproduction and dispersal of most plants and fungi. The origin and structure of spores are very diverse and different in distant taxa. The figures below show the spores of different organisms. Determine the belonging of objects to the Divisions of plants or fungi, and correlate photos with the textual descriptions.

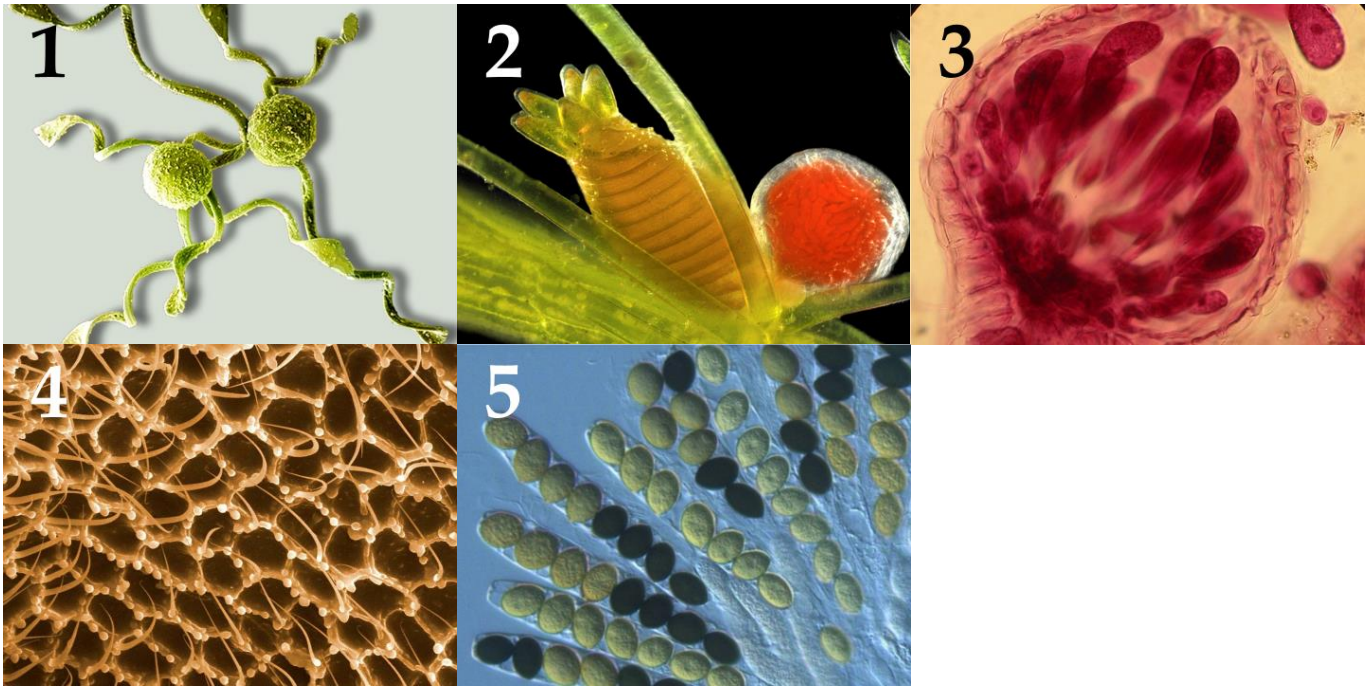

Systematic category (the list is redundant - it contains unnecessary taxa):

- A) Ascomycota;
- B) Basidiomycota;
- C) Chlorophyta (green algae);
- D) Charophyta;
- E) Ochrophyta;
- F) Rhodophyta (red algae);
- G) Bryophyta (mosses);
- H) Polypodiophyta (ferns);

List of descriptions:

- I) The diploid oospore formed because of fertilization within the oogonia;
- II) Haploid spores with elaters formed in the sporangium because of meiosis;
- III) Haploid spores formed exogenously because of meiosis of terminal cells of dikaryotic hyphae;
- IV) Large immobile diploid carpospores formed inside the carposporangium because of mitosis;
- V) Haploid spores formed endogenously inside the sac because of meiosis, followed by a mitotic cell division;

Answer:

Variant 2

Picture	1	2	3	4	5
Systematic category	H	D	F	B	A
Description	II	I	IV	III	V

Task ID 57 – 5 points

Variant 3

The term «spore» derives from the ancient Greek word and means “seed”. These unicellular structures produced the reproduction and dispersal of most plants and fungi. The origin and structure of spores are very diverse and different in distant taxa. The figures below show the spores of different organisms. Determine the belonging of objects to the Divisions of plants or fungi, and correlate photos with the textual descriptions.

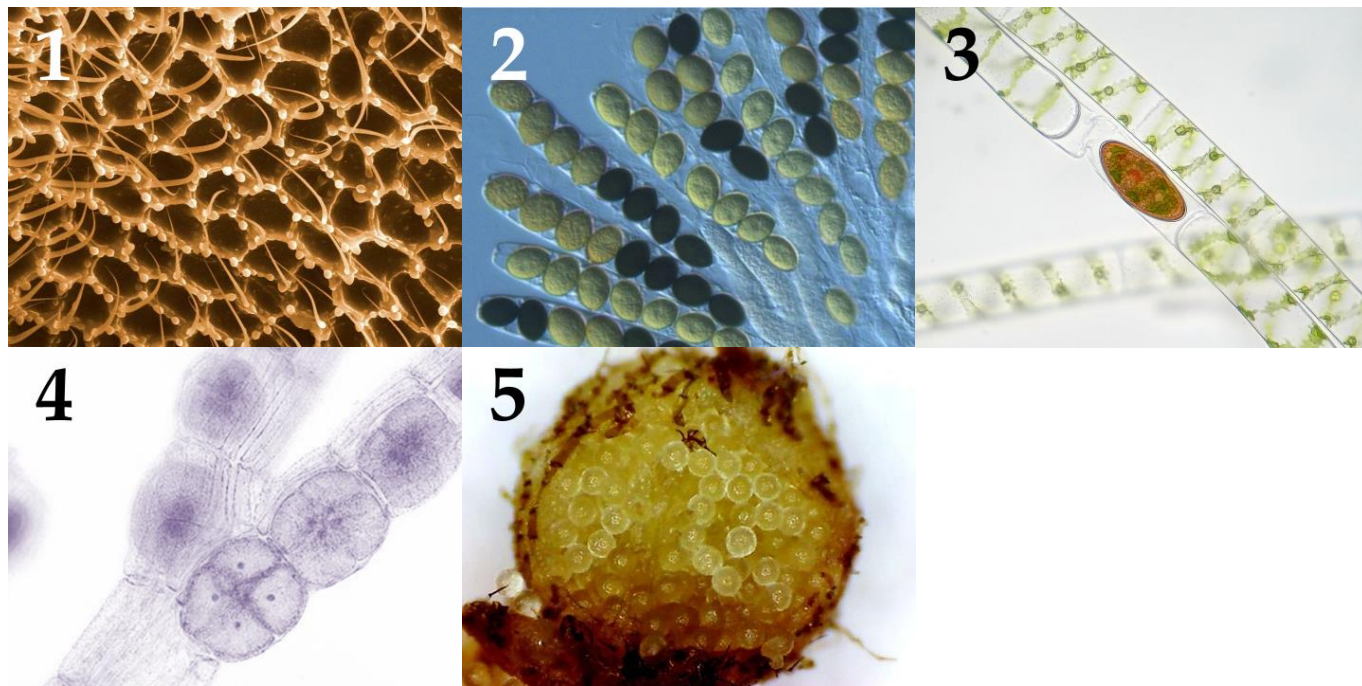

Systematic category (the list is redundant - it contains unnecessary taxa):

- A) Ascomycota;
- B) Basidiomycota;
- C) Chlorophyta (green algae);
- D) Charophyta;
- E) Ochrophyta;
- F) Rhodophyta (red algae);
- G) Bryophyta (mosses);
- H) Polypodiophyta (ferns);

List of descriptions:

- I) Large haploid megaspores formed within the sporocarp because of meiosis;
- II) Diploid zygospores formed because of conjugation;
- III) Haploid spores formed endogenously inside the sac because of meiosis, followed by a mitotic cell division;
- IV) Haploid spores formed by meiosis within tetrasporangium;
- V) Haploid spores formed exogenously because of meiosis of terminal cells of dikaryotic hyphae;

Answer:

Variant 3

Picture	1	2	3	4	5
Systematic category	B	A	D	F	H
Description	V	III	II	IV	I

Task ID 58 – 5 points

Variant 1

Insects (*Insecta*) are the most numerous group of animals on our planet. Match the pictures of insect imago, the taxonomic orders in which they belong and characteristics of those orders:



List of orders of insects (the list is redundant - it contains unnecessary names):

- A) Flies (Order *Diptera*);
- B) Order *Lepidoptera*;
- C) Order *Orthoptera*;
- D) Fleas (order *Siphonaptera*);
- E) Beetles (order *Coleoptera*);
- F) Scorpionflies (order *Mecoptera*);
- G) Order *Hymenoptera*;
- H) True bugs (Order *Hemiptera*);

List of characteristics of insect orders (the list is redundant - it contains unnecessary characteristics):

- I) Complete metamorphosis, chewing mouth apparatus in all life stages, the first pair of wings is modified into sclerotized elytra;
- II) Complete metamorphosis, the mouth apparatus are various derivatives of sucking and sponging types, the second pair of wings is modified into halteres, larvae are legless most of the time;
- III) Complete metamorphosis, piercing mouth apparatus, wings are completely reduced, animal ectoparasites;
- IV) Complete metamorphosis, the mouth apparatus is a syphoning rostrum, wings are covered in colorful scales, imago are often participating in a mutualistic relationship with flowering plants;
- V) Incomplete metamorphosis, chewing mouth apparatus, a lot of species use intraspecific audial signalization – stridulation;
- VI) Complete metamorphosis, chewing mouth apparatus on a rostrum, one of the families is characterized by male reproductive organs shaped like a scorpion abdomen;
- VII) Complete metamorphosis, chewing and lapping mouth apparatus, a great number of contemporary species are parasitoids and eusocial (colonial) insects;

VIII) Incomplete metamorphosis, piercing mouth apparatus, are represented by carnivores, herbivores and parasites;

Answer:

Variant 1

Picture	1	2	3	4	5
Order	F	D	E	C	A
Characteristic	VI	III	I	V	II

Task ID 58 – 5 points

Variant 2

Insects (*Insecta*) are the most numerous group of animals on our planet. Match the pictures of insect imago, the taxonomic orders in which they belong and characteristics of those orders:

1



2



3



4



5



List of orders of insects (the list is redundant - it contains unnecessary names):

- A) Flies (Order Diptera);
- B) Order *Lepidoptera*;
- C) Order *Orthoptera*;
- D) Fleas (order *Siphonaptera*);
- E) Beetles (order *Coleoptera*);
- F) Scorpionflies (order *Mecoptera*);
- G) Order *Hymenoptera*;
- H) True bugs (Order *Hemiptera*);

List of characteristics of insect orders (the list is redundant - it contains unnecessary characteristics):

- I) Complete metamorphosis, chewing mouth apparatus in all life stages, the first pair of wings is modified into sclerotized elytra;
- II) Complete metamorphosis, the mouth apparatus are various derivatives of sucking and sponging types, the second pair of wings is modified into halteres, larvae are legless most of the time;
- III) Complete metamorphosis, piercing mouth apparatus, wings are completely reduced, animal ectoparasites;
- IV) Complete metamorphosis, the mouth apparatus is a syphoning rostrum, wings are covered in colorful scales, imago are often participating in a mutualistic relationship with flowering plants;
- V) Incomplete metamorphosis, chewing mouth apparatus, a lot of species use intraspecific auidial signalization – stridulation;
- VI) Complete metamorphosis, chewing mouth apparatus on a rostrum, one of the families is characterized by male reproductive organs shaped like a scorpion abdomen;
- VII) Complete metamorphosis, chewing and lapping mouth apparatus, a great number of contemporary species are parasitoids and eusocial (colonial) insects;

VIII) Incomplete metamorphosis, piercing mouth apparatus, are represented by carnivores, herbivores and parasites;

Answer:

Variant 2

Picture	1	2	3	4	5
Order	E	C	F	A	D
Characteristic	I	V	VI	II	III

Task ID 58 – 5 points

Variant 3

Insects (*Insecta*) are the most numerous group of animals on our planet. Match the pictures of insect imago, the taxonomic orders in which they belong and characteristics of those orders:

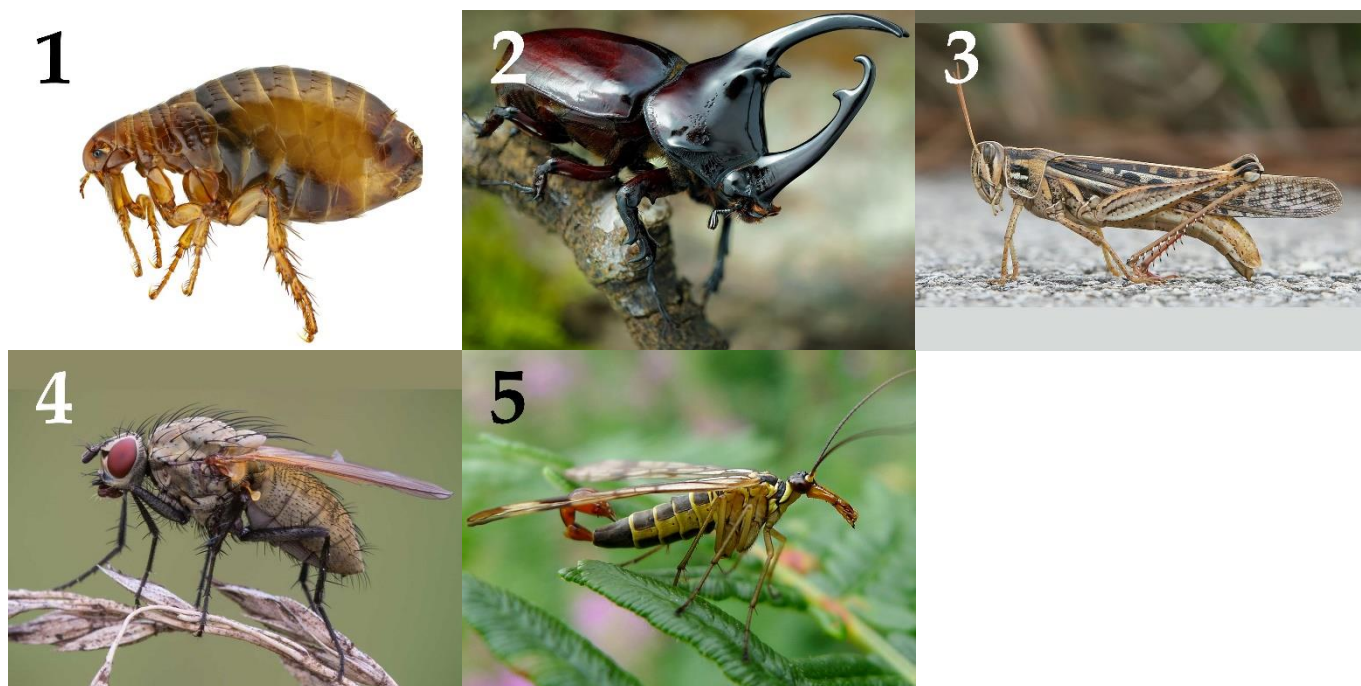

List of orders of insects (the list is redundant - it contains unnecessary names):

- A) Flies (Order Diptera);
- B) Order *Lepidoptera*;
- C) Order *Orthoptera*;
- D) Fleas (order *Siphonaptera*);
- E) Beetles (order *Coleoptera*);
- F) Scorpionflies (order *Mecoptera*);
- G) Order *Hymenoptera*;
- H) True bugs (Order *Hemiptera*);

List of characteristics of insect orders (the list is redundant - it contains unnecessary characteristics):

- I) Complete metamorphosis, chewing mouth apparatus in all life stages, the first pair of wings is modified into sclerotized elytra;
- II) Complete metamorphosis, the mouth apparatus are various derivatives of sucking and sponging types, the second pair of wings is modified into halteres, larvae are legless most of the time;
- III) Complete metamorphosis, piercing mouth apparatus, wings are completely reduced, animal ectoparasites;
- IV) Complete metamorphosis, the mouth apparatus is a syphoning rostrum, wings are covered in colorful scales, imago are often participating in a mutualistic relationship with flowering plants;
- V) Incomplete metamorphosis, chewing mouth apparatus, a lot of species use intraspecific audial signalization – stridulation;
- VI) Complete metamorphosis, chewing mouth apparatus on a rostrum, one of the families is characterized by male reproductive organs shaped like a scorpion abdomen;
- VII) Complete metamorphosis, chewing and lapping mouth apparatus, a great number of contemporary species are parasitoids and eusocial (colonial) insects;

VIII) Incomplete metamorphosis, piercing mouth apparatus, are represented by carnivores, herbivores and parasites;

Answer:

Variant 3

Picture	1	2	3	4	5
Order	D	E	C	A	F
Characteristic	III	I	V	II	VI

Task ID 59 – 5 points*Variant 1*

Mammals have an important feature in addition to feeding their youngsters with milk - the differentiation of teeth by functions. The molars grind food, the premolars help to grab food, tear and grind, the canines tear off pieces of food and hold the prey, the incisors bite.

Environment and type of food that mammal eats determine characteristic of structure of teeth and jaw. Please look at the jaws of different mammals on photos and write to whom they belong, what the animal eats and what kind of life it leads.

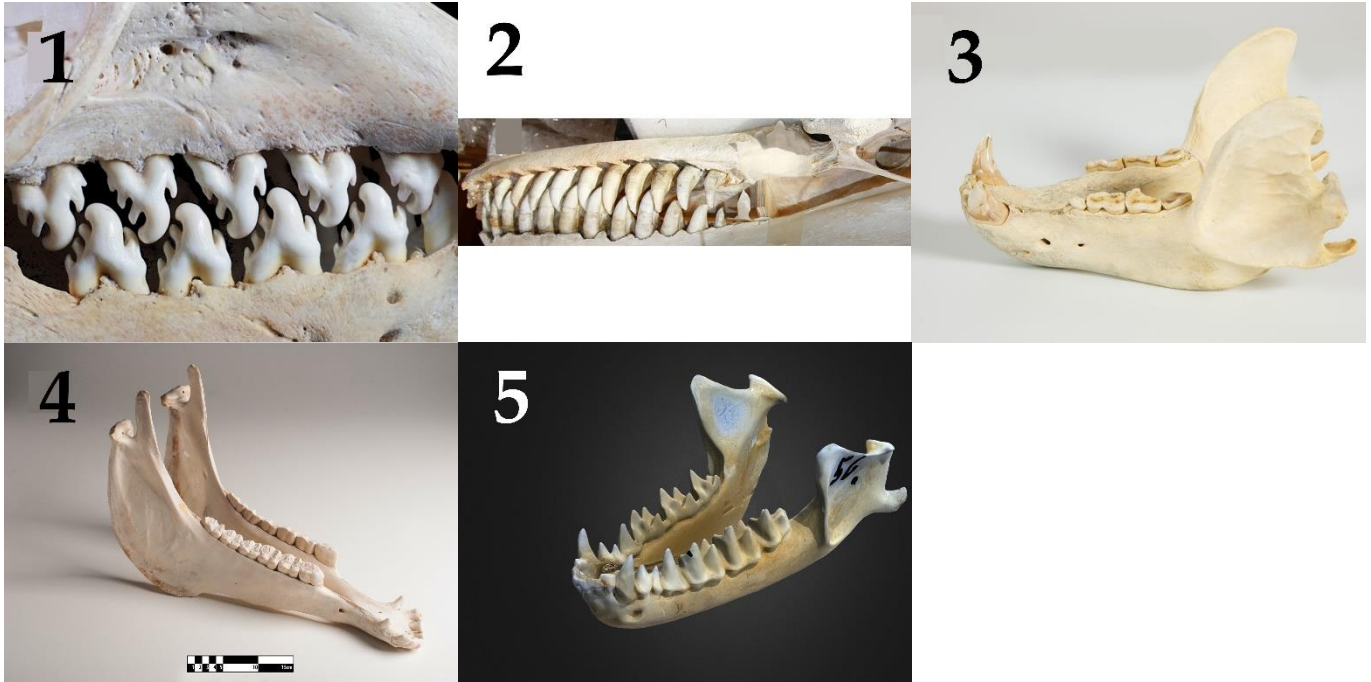
**List of animal names (the list is redundant - it contains unnecessary names):**

- A) Wolf (*Canis lupus*), family *Canidae*;
- B) Killer whale (*Orcinus orca*), family *Delphinidae*;
- C) European hedgehog (*Erinaceus europaeus*), family *Erinaceidae*;
- D) Greater mouse-eared bat (*Myotis myotis*), family *Vespertilionidae*;
- E) Cheetah (*Acinonyx jubatus*), family *Felidae*;
- F) Raccoon dog (*Nyctereutes procyonoides*), family *Canidae*;
- G) Horse (*Equus ferus caballus*), family *Equidae*;
- H) Cow (*Bos taurus*), family *Bovidae*;
- I) Crabeater seal (*Lobodon carcinophaga*), family *Phocidae*;
- J) Brown bear (*Ursus arctos*), family *Ursidae*;

List of characteristics of various animals (the list is redundant - it contains unnecessary characteristics):

- I) Predator, eats exclusively meat. Hunts from an ambush. The fastest land animal.
- II) There are 3 ecotypes which have differences in a food ratio, morphology, habitat and behavior: fish-eating (resident and off-shore) and specializing in eating pinnipeds and whales (transit). They are living in a matriarchal family groups.
- III) Due to its omnivorous nature, this mammal has settled throughout Eurasia. Different populations specialize in eating different types of food - the more northern subspecies are mainly carnivorous, the subspecies of the middle latitudes are mainly eating plant matter, the Far Eastern-North American subspecies feed on fish during the spawning season.
- IV) It has specialization in eating invertebrates – krill.

- V) Eating exclusively vegetation. They graze in pastures, feed on grains and sedges. The upper jaw has incisors.
- VI) Predator that hunts in groups for ungulates. Lives in packs. It focuses mainly on the sense of smell.
- VII) It specializes in feeding on flying insects. Catches prey using echolocation.

Answer:

Variant 1

Picture	1	2	3	4	5
Systematic position	I	B	J	G	D
Characteristic	IV	II	III	V	VII

Task ID 59 – 5 points

Variant 2

Mammals have an important feature in addition to feeding their youngsters with milk - the differentiation of teeth by functions. The molars grind food, the premolars help to grab food, tear and grind, the canines tear off pieces of food and hold the prey, the incisors bite.

Environment and type of food that mammal eats determine characteristic of structure of teeth and jaw. Please look at the jaws of different mammals on photos and write to whom they belong, what the animal eats and what kind of life it leads.

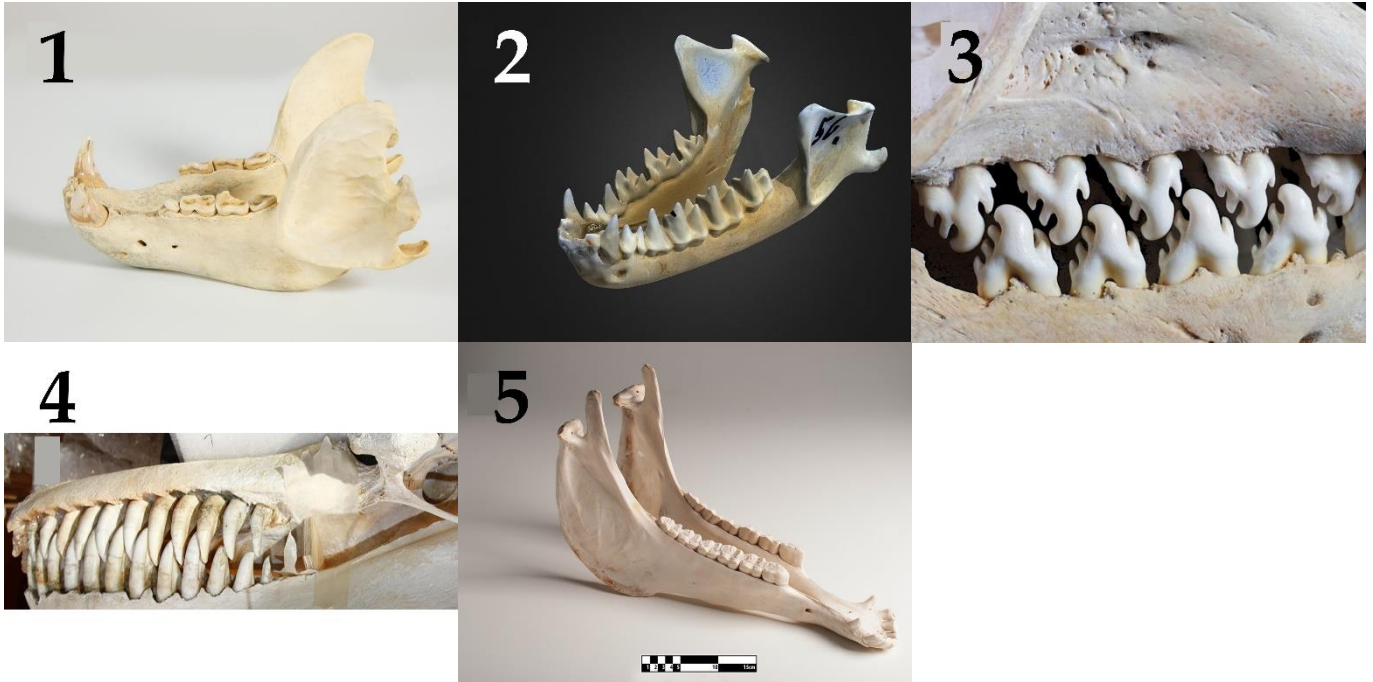

List of animal names (the list is redundant - it contains unnecessary names):

- A) Wolf (*Canis lupus*), family Canidae;
- B) Killer whale (*Orcinus orca*), family Delphinidae;
- C) European hedgehog (*Erinaceus europaeus*), family Erinaceidae;
- D) Greater mouse-eared bat (*Myotis myotis*), family Vespertilionidae;
- E) Cheetah (*Acinonyx jubatus*), family Felidae;
- F) Raccoon dog (*Nyctereutes procyonoides*), family Canidae;
- G) Horse (*Equus ferus caballus*), family Equidae;
- H) Cow (*Bos taurus*), family Bovidae;
- I) Crabeater seal (*Lobodon carcinophaga*), family Phocidae;
- J) Brown bear (*Ursus arctos*), family Ursidae;

List of characteristics of various animals (the list is redundant - it contains unnecessary characteristics):

- I) Due to its omnivorous nature, this mammal has settled throughout Eurasia. Different populations specialize in eating different types of food - the more northern subspecies are mainly carnivorous, the subspecies of the middle latitudes are mainly eating plant matter, the Far Eastern-North American subspecies feed on fish during the spawning season.
- II) There are 3 ecotypes which have differences in a food ratio, morphology, habitat and behavior: fish-eating (resident and off-shore) and specializing in eating pinnipeds and whales (transit). They are living in a matriarchal family groups.
- III) It has specialization in eating invertebrates – krill.
- IV) Eating exclusively vegetation. They graze in pastures, feed on grains and sedges. The upper jaw has incisors.

- V) It specializes in feeding on flying insects. Catches prey using echolocation.
- VI) Predator that hunts in groups for ungulates. Lives in packs. It focuses mainly on the sense of smell.
- VII) Predator, eats exclusively meat. Hunts from an ambush. The fastest land animal.

Answer:

Variant 2

Picture	1	2	3	4	5
Systematic position	J	D	I	B	G
Characteristic	I	V	III	II	IV

Task ID 59 – 5 points

Variant 3

Mammals have an important feature in addition to feeding their youngsters with milk - the differentiation of teeth by functions. The molars grind food, the premolars help to grab food, tear and grind, the canines tear off pieces of food and hold the prey, the incisors bite.

Environment and type of food that mammal eats determine characteristic of structure of teeth and jaw. Please look at the jaws of different mammals on photos and write to whom they belong, what the animal eats and what kind of life it leads.

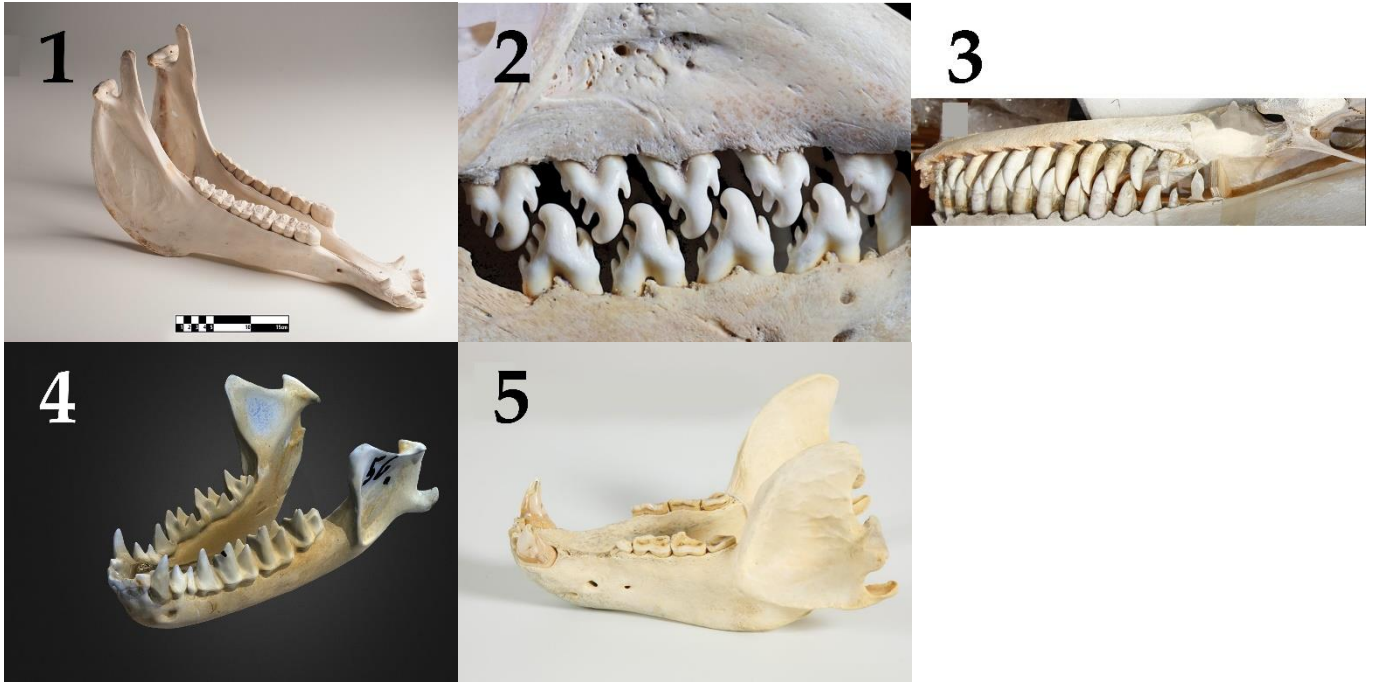

List of animal names (the list is redundant - it contains unnecessary names):

- A) Wolf (*Canis lupus*), family Canidae;
- B) Killer whale (*Orcinus orca*), family Delphinidae;
- C) European hedgehog (*Erinaceus europaeus*), family Erinaceidae;
- D) Greater mouse-eared bat (*Myotis myotis*), family Vespertilionidae;
- E) Cheetah (*Acinonyx jubatus*), family Felidae;
- F) Raccoon dog (*Nyctereutes procyonoides*), family Canidae;
- G) Horse (*Equus ferus caballus*), family Equidae;
- H) Cow (*Bos taurus*), family Bovidae;
- I) Crabeater seal (*Lobodon carcinophaga*), family Phocidae;
- J) Brown bear (*Ursus arctos*), family Ursidae;

List of characteristics of various animals (the list is redundant - it contains unnecessary characteristics):

- I) Predator, eats exclusively meat. Hunts from an ambush. The fastest land animal.
- II) Predator that hunts in groups for ungulates. Lives in packs. It focuses mainly on the sense of smell.
- III) It specializes in feeding on flying insects. Catches prey using echolocation.
- IV) Eating exclusively vegetation. They graze in pastures, feed on grains and sedges. The upper jaw has incisors.
- V) It has specialization in eating invertebrates – krill.
- VI) There are 3 ecotypes which have differences in a food ratio, morphology, habitat and behavior: fish-eating (resident and off-shore) and specializing in eating pinnipeds and whales (transit). They are living in a matriarchal family groups.

- VII) Due to its omnivorous nature, this mammal has settled throughout Eurasia. Different populations specialize in eating different types of food - the more northern subspecies are mainly carnivorous, the subspecies of the middle latitudes are mainly eating plant matter, the Far Eastern-North American subspecies feed on fish during the spawning season.

Answer:

Variant 3

Picture	1	2	3	4	5
Systematic position	G	I	B	D	J
Characteristic	IV	V	VI	III	VII

Task ID 60 – 5 points*Variant 1*

A human receives information about the external world and internal state of the body through receptors, which leads to activation of reflexes through reflex arcs. Relate elements of reflex arcs to each other.

List of receptor names (sensory cells):

1. Inner hair cells of cochlea;
2. Baroreceptors of aorta;
3. Meissner's corpuscles;
4. Cones;
5. Olfactory receptors;

List of conducting paths (the list is redundant, it contains unnecessary elements):

- A) Optic tract;
- B) Vestibulocochlear nerve;
- C) Olfactory tract;
- D) Spinal nerves;
- E) Trigeminal nerve;
- F) Glossopharyngeal nerve;
- G) Vagus nerve;

List of signal processing structure in central nervous system:

- I) Sensomotor area of cerebral cortex;
- II) Occipital lobe of cerebral cortex;
- III) Solitary nucleus (medulla oblongata);
- IV) Septum pellucidum;
- V) Temporal lobe of cerebral cortex;

Answer:*Variant 1*

Receptor	1	2	3	4	5
Conducting path	B	G	D	A	C
CNS structure	V	III	I	II	IV

Task ID 60 – 5 points*Variant 2*

A human receives information about the external world and internal state of the body through receptors, which leads to activation of reflexes through reflex arcs. Relate elements of reflex arcs to each other.

List of receptor names (sensory cells):

1. Ruffini corpuscle;
2. Outer hair cells of cochlea;
3. Olfactory receptors;
4. Taste papillae of posterior third of tongue;
5. Rod cell;

List of conducting paths (the list is redundant, it contains unnecessary elements):

- A) Optic tract;
- B) Vestibulocochlear nerve;
- C) Olfactory tract;
- D) Spinal nerves;
- E) Trigeminal nerve;
- F) Glossopharyngeal nerve;
- G) Vagus nerve;

List of signal processing structure in central nervous system:

- I) Insular lobe of cerebral cortex;
- II) Sensomotor area of cerebral cortex;
- III) Temporal lobe of cerebral cortex;
- IV) Septum pellucidum;
- V) Occipital lobe of cerebral cortex;

Answer:*Variant 2*

Receptor	1	2	3	4	5
Conducting path	D	B	C	F	A
CNS structure	II	III	IV	I	V

Task ID 60 – 5 points*Variant 3*

A human receives information about the external world and internal state of the body through receptors, which leads to activation of reflexes through reflex arcs. Relate elements of reflex arcs to each other.

List of receptor names (sensory cells):

1. Pain receptors of forehead skin;
2. Hair cells of semicircular canals;
3. Cones;
4. Olfactory receptors;
5. Meissner's corpuscles;

List of conducting paths (the list is redundant, it contains unnecessary elements):

- A) Optic tract;
- B) Vestibulocochlear nerve;
- C) Olfactory tract;
- D) Spinal nerves;
- E) Trigeminal nerve;
- F) Glossopharyngeal nerve;
- G) Vagus nerve;

List of signal processing structure in central nervous system:

- I) The nucleus of superficial sensitivity of nerve V;
- II) Cerebellum;
- III) Sensomotor area of cerebral cortex;
- IV) Occipital lobe of cerebral cortex;
- V) Septum pellucidum;

Answer:*Variant 3*

Receptor	1	2	3	4	5
Conducting path	E	B	A	C	D
CNS structure	II	I	IV	V	III

Task ID 61 – 5 points

Variant 1

The photographs below show histological sections of five different organs.

Match the histological sections shown in the photographs with the name of the main cell type that can be identified on them and with the appropriate functional characteristic for that cell type.

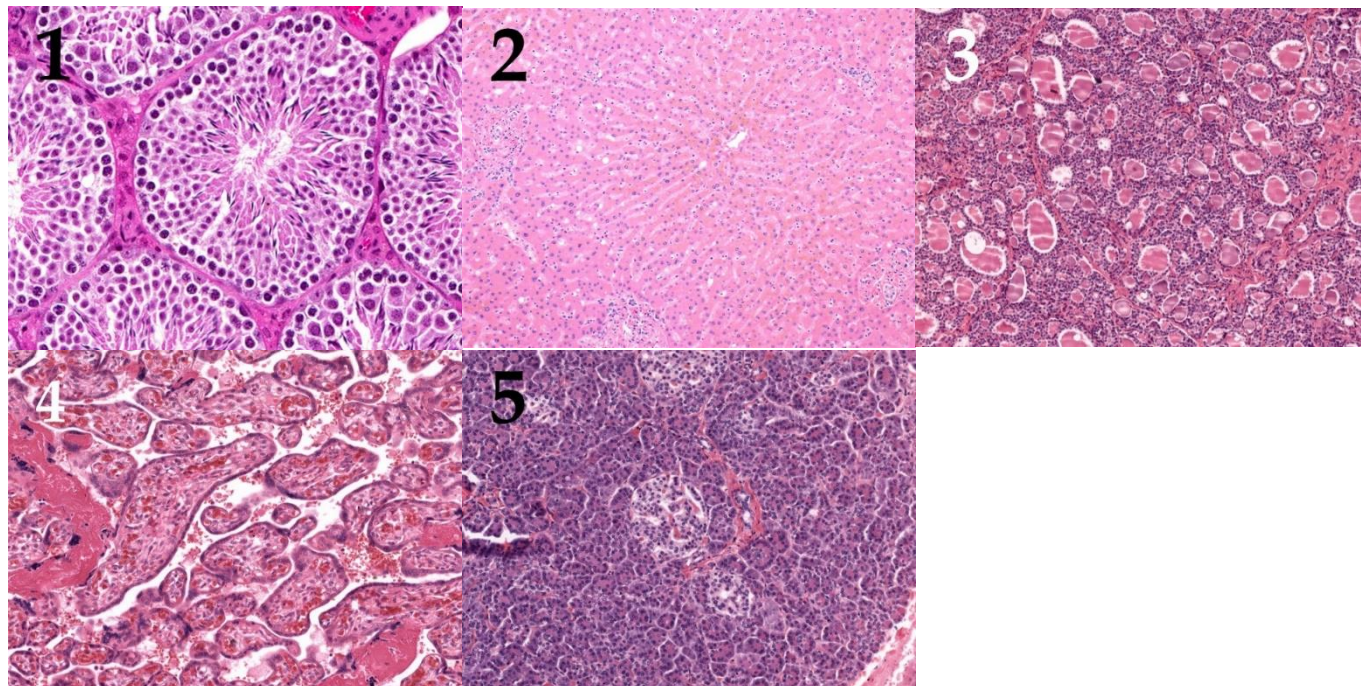
**List of cell types (this list is redundant - it contains unnecessary names):**

- A) Kupffer cells (specialized macrophages whose primary role is to remove foreign agents entering hepatic portal system);
- B) Sertoli cells (cells that provide nourishment to developing germ cells and play important role in endocrine regulation of spermatogenesis);
- C) Purkinje cells (large inhibitory neurons whose axons constitute the sole output from cerebellar cortex);
- D) Juxtaglomerular cells (specialized cells within afferent arteriole wall in kidneys that are engaged in arterial pressure regulation);
- E) Beta-cells (insulin secreting cells);
- F) Decidual cells (cells that are thought crucial for immune tolerance towards the fetus during pregnancy);
- G) Follicular cells (cells lining thyroid follicles);
- H) Parietal cells (hydrochloric acid producing cells).

List of functional characteristics of cells:

- I) These cells are located in the capillary lumen;
- II) These cells can be found adjacent to cells that secrete glucagon, somatostatin or ghrelin;
- III) These cells express follicle-stimulating hormone receptors;
- IV) During embryogenesis these cells develop from endodermal cells near the root of the tongue;
- V) These cells differentiate from endometrial stromal fibroblasts.

Answer:

Variant 1

Photograph	1	2	3	4	5
Cell type	B	A	G	F	E
Characteristic	III	I	IV	V	II

Task ID 61 – 5 points

Variant 2

The photographs below show histological sections of five different organs. Match the histological sections shown in the photographs with the name of the main cell type that can be identified on them and with the appropriate functional characteristic for that cell type.

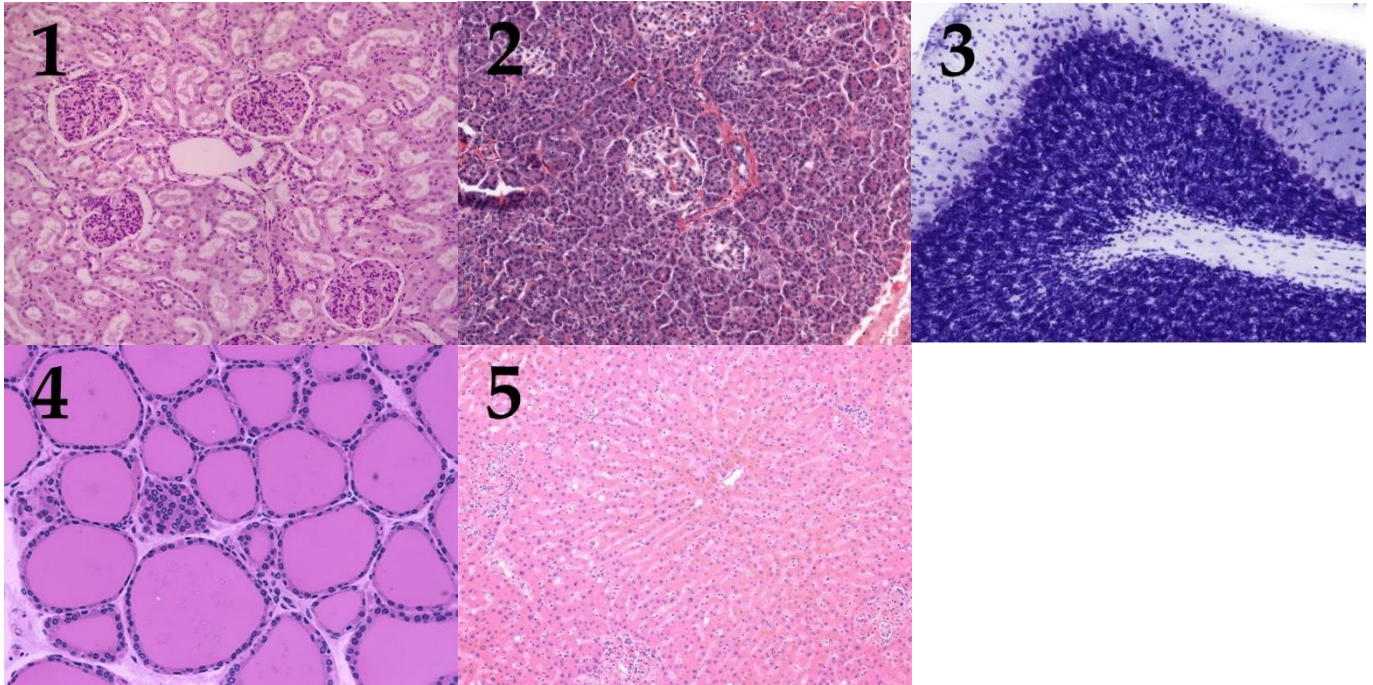
**List of cell types (this list is redundant - it contains unnecessary names):**

- A) Kupffer cells (specialized macrophages whose primary role is to remove foreign agents entering hepatic portal system);
- B) Sertoli cells (cells that provide nourishment to developing germ cells and play important role in endocrine regulation of spermatogenesis);
- C) Purkinje cells (large inhibitory neurons whose axons constitute the sole output from cerebellar cortex);
- D) Juxtaglomerular cells (specialized cells within afferent arteriole wall in kidneys that are engaged in arterial pressure regulation);
- E) Beta-cells (insulin secreting cells);
- F) Decidual cells (cells that are thought crucial for immune tolerance towards the fetus during pregnancy);
- G) Follicular cells (cells lining thyroid follicles);
- H) Parietal cells (hydrochloric acid producing cells).

List of functional characteristics of cells:

- I) These cells are specialized smooth muscle cells;
- II) These cells express major histocompatibility complex class II molecules;
- III) These cells can be found adjacent to cells that secrete glucagon, somatostatin or ghrelin;
- IV) These cells have ectodermal origin.
- V) The secretory activity of these cells is regulated by hypophysis.

Answer:

Variant 2

Photograph	1	2	3	4	5
Cell type	D	E	C	G	A
Characteristic	I	III	IV	V	II

Task ID 61 – 5 points

Variant 3

The photographs below show histological sections of five different organs.

Match the histological sections shown in the photographs with the name of the main cell type that can be identified on them and with the appropriate functional characteristic for that cell type.

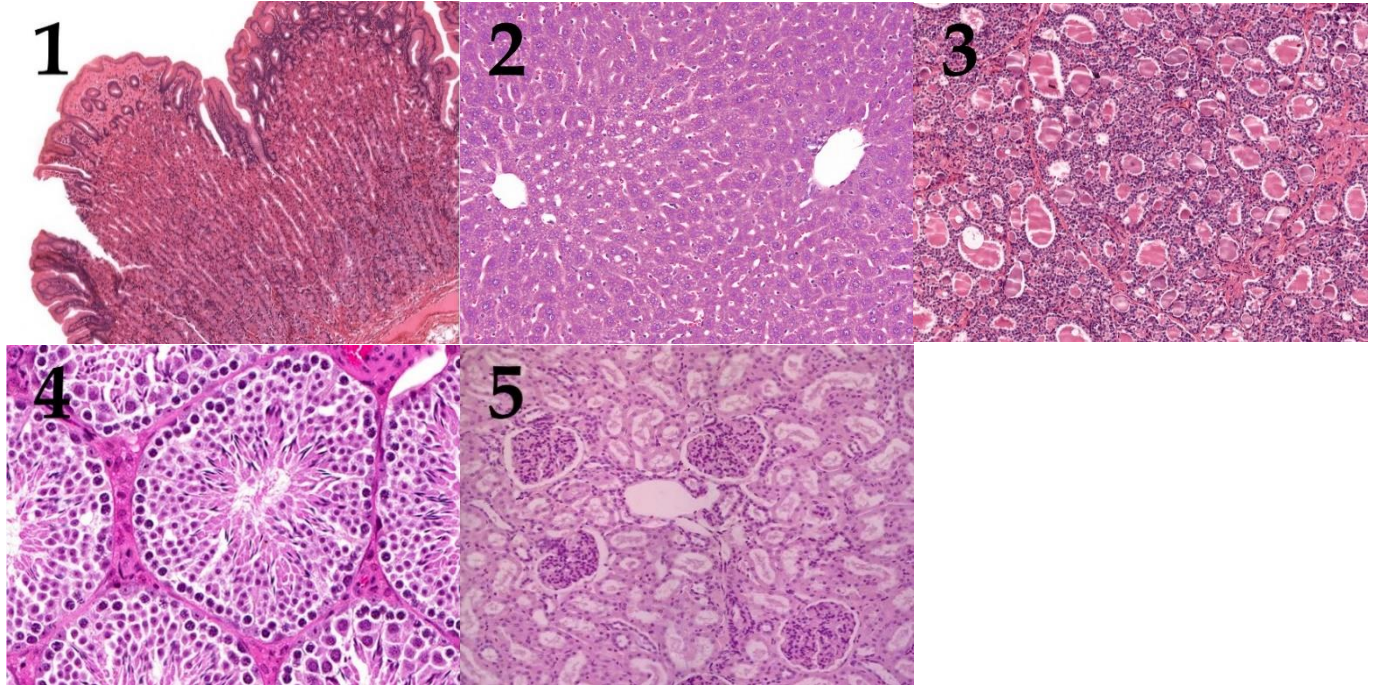
**List of cell types (this list is redundant - it contains unnecessary names):**

- A) Kupffer cells (specialized macrophages whose primary role is to remove foreign agents entering hepatic portal system);
- B) Sertoli cells (cells that provide nourishment to developing germ cells and play important role in endocrine regulation of spermatogenesis);
- C) Purkinje cells (large inhibitory neurons whose axons constitute the sole output from cerebellar cortex);
- D) Juxtaglomerular cells (specialized cells within afferent arteriole wall in kidneys that are engaged in arterial pressure regulation);
- E) Beta-cells (insulin secreting cells);
- F) Decidual cells (cells that are thought crucial for immune tolerance towards the fetus during pregnancy);
- G) Follicular cells (cells lining thyroid follicles);
- H) Parietal cells (hydrochloric acid producing cells).

List of functional characteristics of cells:

- I) During peak secretory activity the apical membrane surface of these cells is dramatically expanded by fusion of preformed vesicles with plasma membrane;
- II) These cells play a vital role in maintaining blood-tissue barrier in the organ they reside in;
- III) These cells are specialized smooth muscle cells;
- IV) During embryogenesis these cells originate between first and second pharyngeal pouches;
- V) These cells express major histocompatibility complex class II molecules;

Answer:

Variant 3

Photograph	1	2	3	4	5
Cell type	H	A	G	B	D
Characteristic	I	V	IV	II	III

Task ID 62 – 5 points

Variant 1

Functional activity and structure of protein is usually regulated by posttranslational modifications. In the pictures below some of the modified aminoacids are presented. Compare the formulas of modified amino acids with their names and with their role in functional activity of proteins in cell.

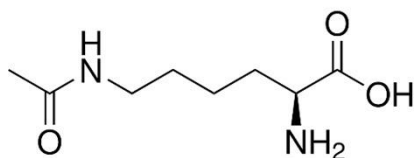
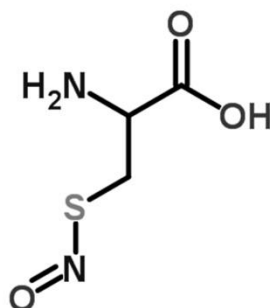
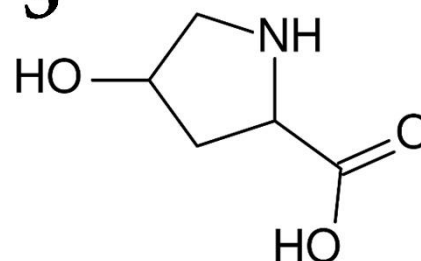
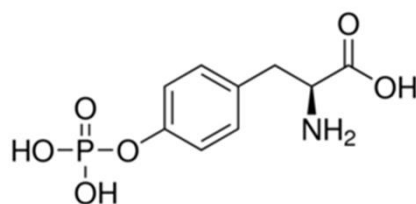
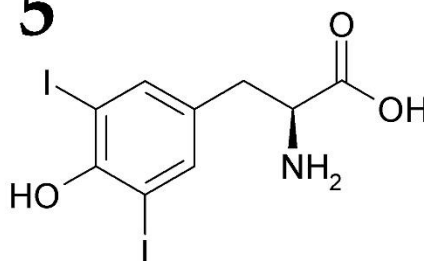
1**2****3****4****5**

List of modified amino acids (the list is redundant - it contains unnecessary names):

- A) Diiodotyrosine;
- B) 4-Hydroxyproline;
- C) N-acetylglucosamine threonine;
- D) Acetyl lysine;
- E) Gamma-carboxyglutamic acid;
- F) S-Nitrosocysteine;
- G) O-Phosphotyrosine;
- H) Phosphoserine;

List of functions for amino acids with various post-translational modifications (the list is redundant - it contains unnecessary descriptions):

- I) Acts as a part of signal transducing pathway during insulin receptor activation;
- II) Blocks some of phosphorylation sites in protein;
- III) Decreases positive charge of a protein, participates in chromatin remodeling;
- IV) Binds calcium ion with great affinity, participates in the blood coagulation process;
- V) During ischemia acts as a potent vasodilatation factor;
- VI) Participates in correct collagen structure assembly;
- VII) Regulated phosphorylase b kinase;
- VIII) Acts as a precursor in the synthesis of potent metabolic hormone;

Answer:

Variant 1

Formula	1	2	3	4	5
Modified amino acids	D	F	B	G	A
Functions	III	V	VI	I	VIII

Task ID 62 – 5 points

Variant 2

Functional activity and structure of protein is usually regulated by posttranslational modifications. In the pictures below some of the modified amino acids are presented. Compare the formulas of modified amino acids with their names and with their role in functional activity of proteins in cell.

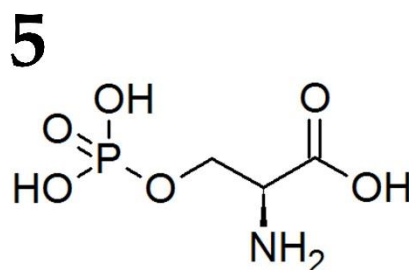
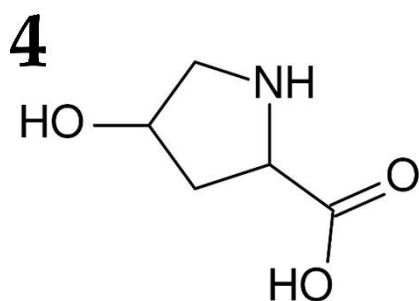
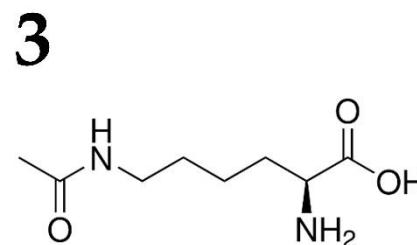
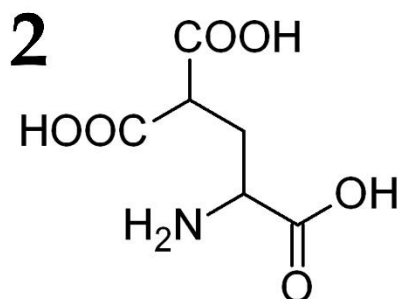
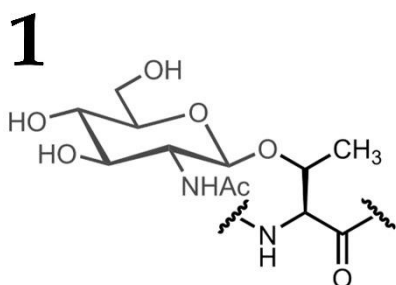

List of modified amino acids (the list is redundant - it contains unnecessary names):

- A) Diiodotyrosine;
- B) 4-Hydroxyproline;
- C) N-acetylglucosamine threonine;
- D) Acetyl lysine;
- E) Gamma-carboxyglutamic acid;
- F) S-Nitrosocysteine;
- G) O-Phosphotyrosine;
- H) Phosphoserine;

List of functions for amino acids with various post-translational modifications (the list is redundant - it contains unnecessary descriptions):

- I) Acts as a part of signal transducing pathway during insulin receptor activation;
- II) Blocks some of phosphorylation sites in protein;
- III) Decreases positive charge of a protein, participates in chromatin remodeling;
- IV) Binds calcium ion with great affinity, participates in the blood coagulation process;
- V) During ischemia acts as a potent vasodilatation factor;
- VI) Participates in correct collagen structure assembly;
- VII) Regulated phosphorylase b kinase;
- VIII) Acts as a precursor in the synthesis of potent metabolic hormone;

Answer:

Variant 2

Formula	1	2	3	4	5
Modified amino acids	C	E	D	B	H
Functions	II	IV	III	VI	VII

Task ID 62 – 5 points

Variant 3

Functional activity and structure of protein is usually regulated by posttranslational modifications. In the pictures below some of the modified amino acids are presented. Compare the formulas of modified amino acids with their names and with their role in functional activity of proteins in cell.

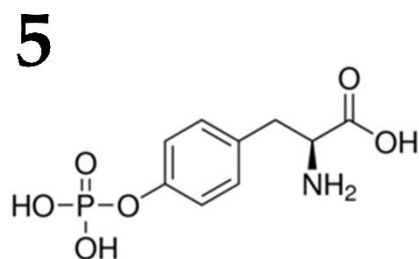
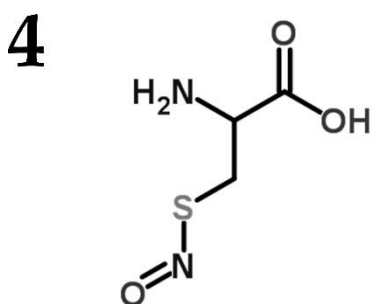
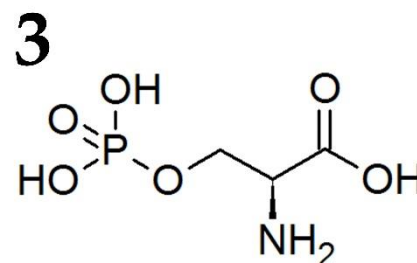
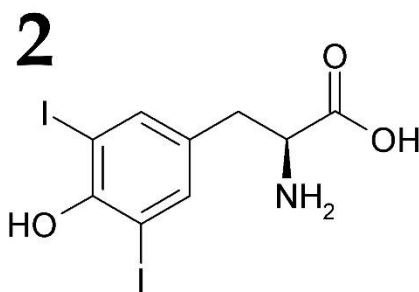
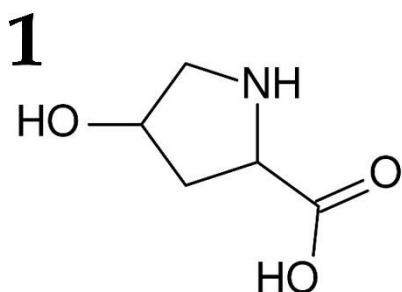

List of modified amino acids (the list is redundant - it contains unnecessary names):

- A) Diiodotyrosine;
- B) 4-Hydroxyproline;
- C) N-acetylglucosamine threonine;
- D) Acetyl lysine;
- E) Gamma-carboxyglutamic acid;
- F) S-Nitrosocysteine;
- G) O-Phosphotyrosine;
- H) Phosphoserine;

List of functions for amino acids with various post-translational modifications (the list is redundant - it contains unnecessary descriptions):

- I) Acts as a part of signal transducing pathway during insulin receptor activation;
- II) Blocks some of phosphorylation sites in protein;
- III) Decreases positive charge of a protein, participates in chromatin remodeling;
- IV) Binds calcium ion with great affinity, participates in the blood coagulation process;
- V) During ischemia acts as a potent vasodilatation factor;
- VI) Participates in correct collagen structure assembly;
- VII) Regulated phosphorylase b kinase;
- VIII) Acts as a precursor in the synthesis of potent metabolic hormone;

Answer:

Variant 3

Formula	1	2	3	4	5
Modified amino acids	B	A	H	F	G
Functions	VI	VIII	VII	V	I

Task ID 64 – 5 points

Variant 1

These images were obtained from scanning electron microscope. Define cells on them and correlate each type of cells with disease linked with their dysregulation:

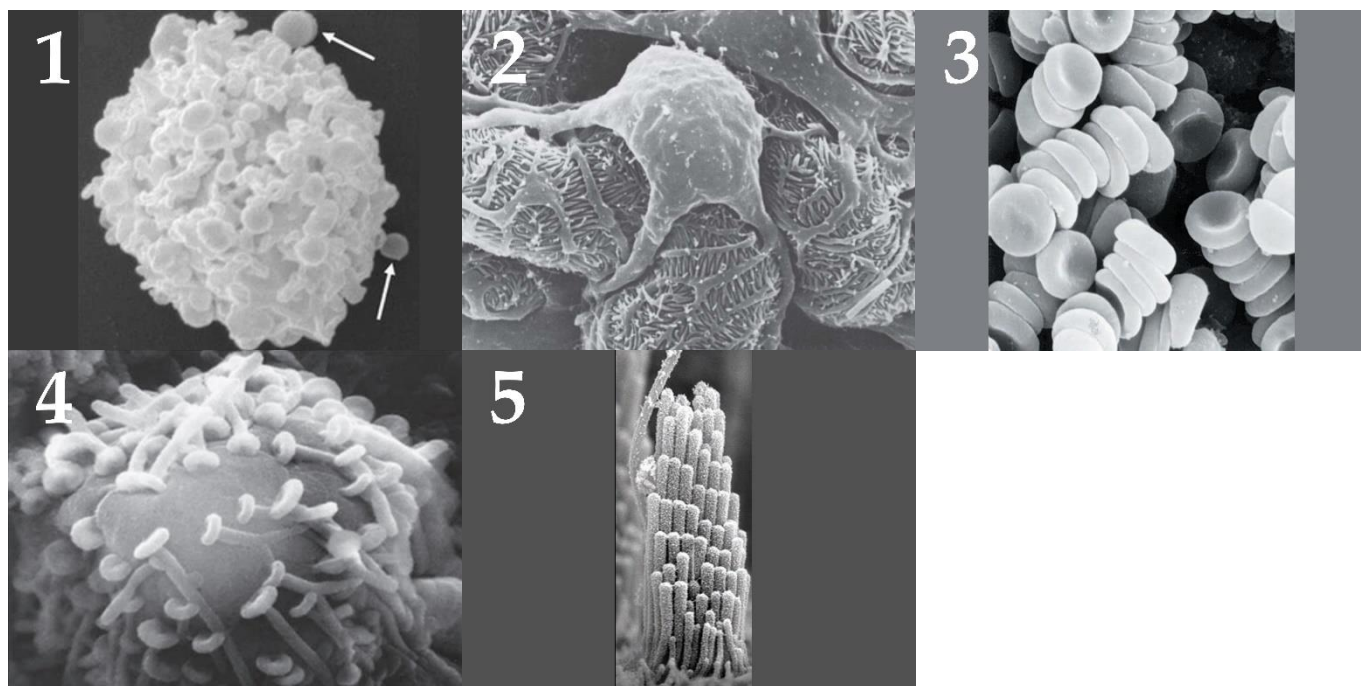

List of cell types (the list is redundant - it contains unnecessary names):

- A) Podocyte;
- B) Neuron;
- C) Erythrocyte;
- D) Hair cell;
- E) Mast cell;
- F) Ciliary epitheliocyte of the trachea;

List of diseases associated with a malfunction of this type of cells (the list is redundant - it contains unnecessary names):

- I) Haemophilia;
- II) Hearing loss;
- III) Kidney failure;
- IV) Allergy;
- V) Parkinson disease;
- VI) Bronchopulmonary diseases;

Answer:

Variant 1

Picture	1	2	3	4	5
Cell type	E	A	C	B	D
Disease	IV	III	I	V	II

Task ID 64 – 5 points

Variant 2

These images were obtained from scanning electron microscope. Define cells on them and correlate each type of cells with disease linked with their dysregulation:

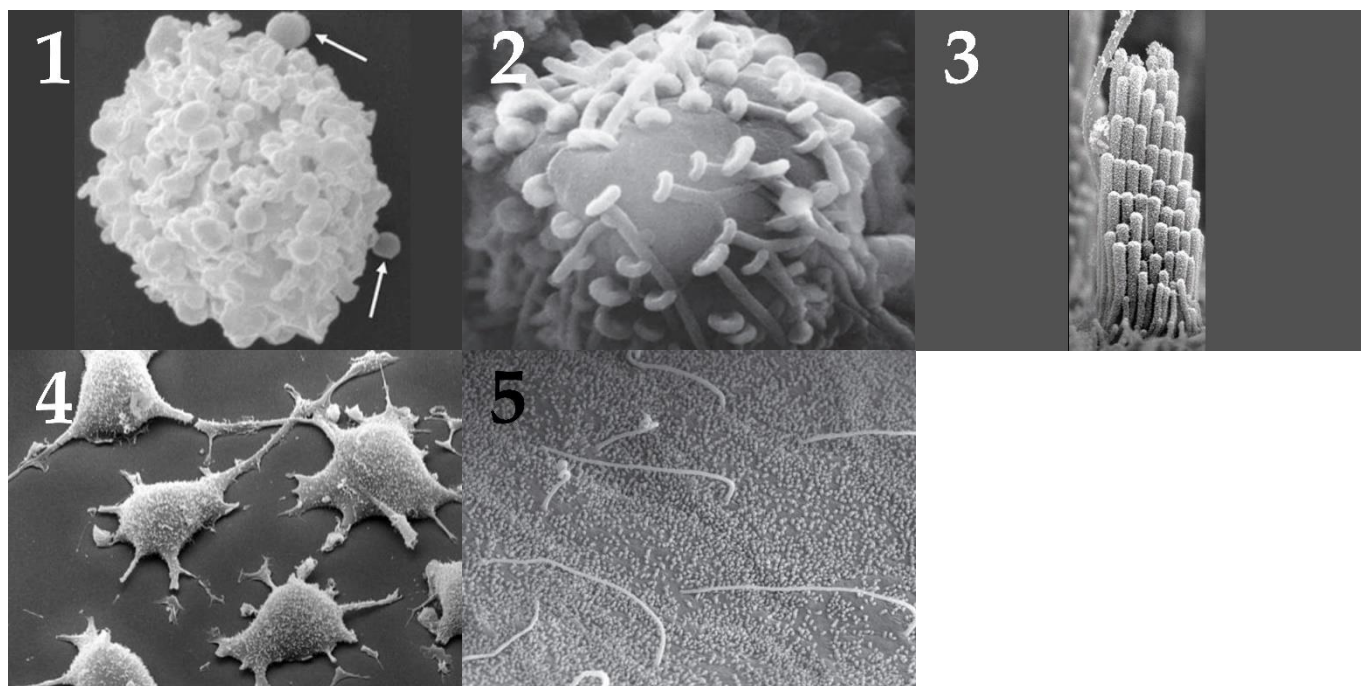

List of cell types (the list is redundant - it contains unnecessary names):

- A) Podocyte;
- B) Neuron;
- C) Hair cell;
- D) Fibroblast;
- E) Mast cell;
- F) Cholangiocyte (bile duct lining cell);

List of diseases associated with a malfunction of this type of cells (the list is redundant - it contains unnecessary names):

- I) Hearing loss;
- II) Fibrosis;
- III) Primary biliary cirrhosis;
- IV) Allergy;
- V) Parkinson disease;
- VI) Kidney failure;

Answer:

Variant 2

Picture	1	2	3	4	5
Cell type	E	B	C	D	F
Disease	IV	V	I	II	III

Task ID 64 – 5 points

Variant 3

These images were obtained from scanning electron microscope. Define cells on them and correlate each type of cells with disease linked with their dysregulation:

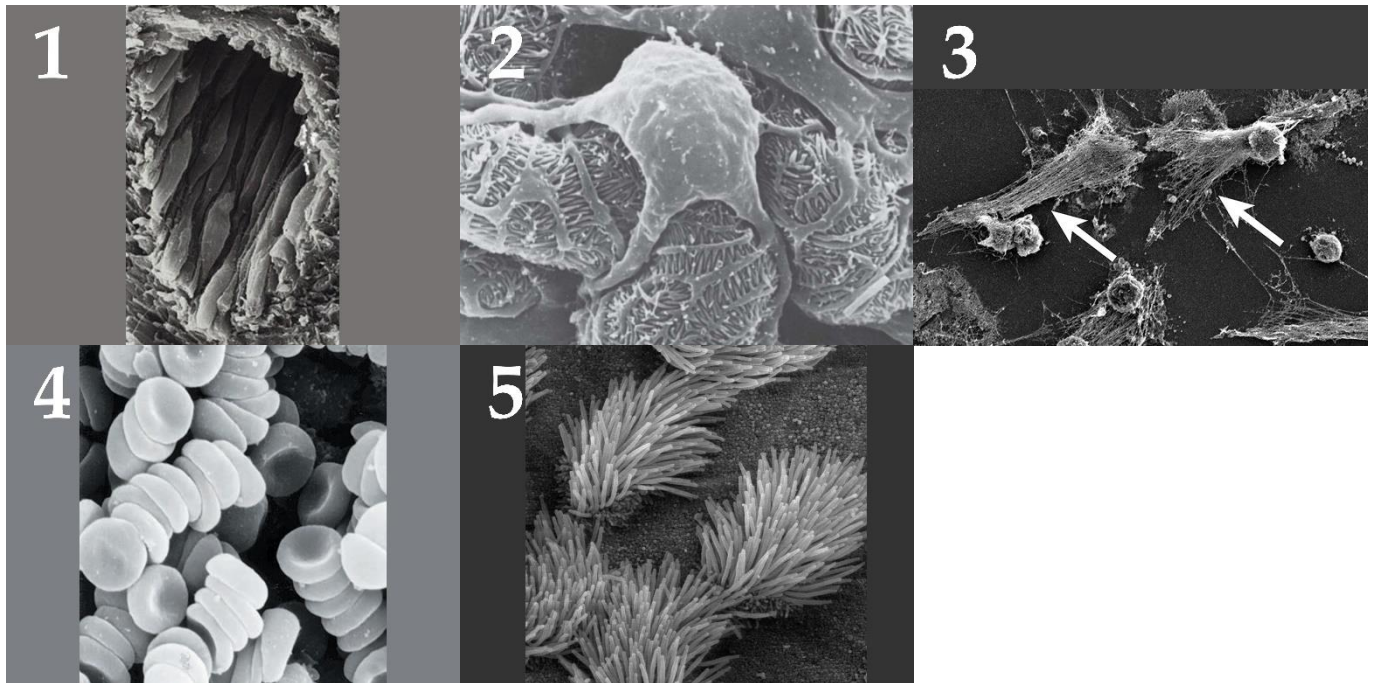

List of cell types (the list is redundant - it contains unnecessary names):

- A) Podocyte;
- B) Neuron;
- C) Endotheliocyte;
- D) Erythrocyte;
- E) Neutrophil;
- F) Ciliary epitheliocyte of the trachea;

List of diseases associated with a malfunction of this type of cells (the list is redundant - it contains unnecessary names):

- I) Haemophilia;
- II) Kidney failure;
- III) Bronchopulmonary diseases;
- IV) Systemic lupus erythematosus;
- V) Atherosclerosis;
- VI) Parkinson disease;

Answer:

Variant 3

Picture	1	2	3	4	5
Cell type	C	A	E	D	F
Disease	V	II	IV	I	III